

# Network Options Assessment Report Methodology

## Electricity System Operator

May 2020

---

Version	DRAFT 6.1
---------	-----------

---

Date	15/05/2020
------	------------

---

### About this document

This document contains National Grid Electricity System Operator (ESO)'s Network Options Assessment (NOA) report methodology established under the Electricity Transmission Licence Standard Condition C27 in respect of the financial year 2020/21. It covers the methodology on which National Grid ESO, will base the NOA which will be published by 31 January 2021. As the methodology evolves due to experience and stakeholder feedback, the methodology statement will be revised for subsequent NOAs as required by Licence Condition C27.

# Contents

Introduction .....	2
The NOA report process .....	10
Network Options Assessment for Interconnectors .....	31
Suitability for third party delivery and tendering assessment .....	46
ESO process for Offshore Wider Works .....	53
ESO process for High Voltage and Stability Management .....	64
Early development of options.....	91
Appendix A NOA study matrix .....	94
Appendix B System requirements form.....	97
Appendix C Process for checking NOA option cost reasonableness .....	103
Appendix D Form of report.....	108
Appendix E Summary of stakeholder feedback .....	111





# 1

## Introduction

## Purpose

- 1.1 The purpose of the Network Options Assessment (NOA) is to facilitate the development of an efficient, coordinated and economical system of electricity transmission consistent with the National Electricity Transmission System Security and Quality of Supply Standard and the development of efficient interconnection capacity.
- 1.2 This document provides an overview of the aims of the NOA and details the methodology which describes how the Electricity System Operator (ESO) assesses the required levels of network transfer requirement, the options available to meet this requirement and the ESO's recommended options for further development. It is important to note that whilst the ESO recommends progressing options in order to meet system needs, any investment decisions remain with the Transmission Owners (TOs) or other relevant parties as appropriate.
- 1.3 This methodology document describes the end to end process for the analysis and publishing of the NOA report and identifies the roles and responsibilities of the ESO and TOs. It includes timescales from Electricity Transmission Standard Licence Condition C27 but the Authority can change these in which case the NOA timescales mentioned below will change.
- 1.4 Where this methodology refers to 'TOs', it means onshore TOs.

## Key changes for 2020/21

- 1.5 Our Network Development Roadmap, launched in 2018 and updated early in 2020 aims to focus on developments to drive additional value to consumers. It includes extending the range of needs the NOA approach applies to and the participants and options that can be put forward. We are building the capability and testing the value through a number of pathfinding projects. Where relevant we intend to include any applicable options in the 2020/21 economic analysis. We report the pathfinding projects separately on our Network Development Roadmap website<sup>1</sup> and through the Electricity Networks Association (ENA) Open Networks Project<sup>2</sup>.
- 1.6 We have updated our high voltage management process following feedback from the Mersey pathfinder project and we have added further explanation to the effectiveness methodology.
- 1.7 We have added the ESO process for stability management into Section 6 (with the ESO process for high voltage management) in the NOA 2020/21 methodology as we said we would in the ESO Forward Plan.
- 1.8 The NOA 2019/20 recommended investment in three ESO-led commercial solutions. We have included in the NOA 2020/21 methodology our approach to Commercial Options; see section 2. The ESO is keen to encourage commercial solutions providers to support our obligations for operating the system and we'll continue to hold events to support this interest.
- 1.9 Ofgem has announced its decision on the Licence Condition C27 consultation that it undertook from December 2019 to January 2020. In response, we have published our approach to early development of options in this methodology in section 7. The C27 changes also introduce assessments of options and connection projects for their eligibility for competition. Last year's methodology already described our processes for eligibility assessments so we've made no major changes this year.
- 1.10 We continue to enhance and evolve the way we undertake our analysis. We recognise that the most challenging system needs are no longer just at the winter peak demand background. This is mainly due to ever increasing level of interconnections and renewable energy resources which bring greater volatility and intermittency to generation and demand patterns. As the energy background evolves, using a deterministic approach based on winter peak conditions to identify year-round system requirements may result in an overly optimistic or pessimistic view of system needs. We have carried out some probabilistic analysis in the last two NOAs and we continue to develop this area and cover more years and boundaries. This

---

<sup>1</sup> <https://www.nationalgrideso.com/insights/network-options-assessment-noa/network-development-roadmap>

<sup>2</sup> <https://www.energynetworks.org/electricity/futures/open-networks-project>

- helps us to verify boundary capability limitations and allows us to find new potential issues to investigate.
- 1.11 For the last two years we have developed electronic SRF templates and in 2020/21 we are developing the SRF and boundary capability parts into a SharePoint form. This will allow data checking on entry and improve data handling. The TOs have worked with us on the templates and we aim to deliver a smoother handover process of information for this cycle.
- 1.12 For this year's NOA IC, we continue to evolve the methodology based on stakeholder feedback. The work is focussed on the core iterative analysis with an emphasis on providing as much insight and value as possible without unnecessary detail and complexity, as requested by stakeholders.

## Key similarities to 2019/20

- 1.13 The overall NOA process and philosophy are the same as used last year. Our NOA Methodology review that we submitted to Ofgem in March 2017 concluded that single year regret analysis is the best way to evaluate the needs of the national electricity transmission system. You can find the review document at <https://www.nationalgrid.com/sites/default/files/documents/NOA%20Methodology%20Review%202017.pdf>.
- 1.14 For the NOA 2020/21, we will continue to operate the NOA Committee to provide additional scrutiny throughout the NOA process. NOA Committee members bring expertise from different parts of the ESO to ensure that the NOA recommendations are robust and in the best interest of GB's consumers. You can find the minutes of the past NOA Committee meetings on the NOA webpage at <https://www.nationalgrideso.com/insights/network-options-assessment-noa>.

## Background

- 1.15 In order to recommend options, the ESO uses the established investment recommendation process. This ultimately leads to the selection of recommended options based upon their capital investment and constraint savings across a range of scenarios. Constraint costs are a factor of bid/offer prices and the amount of generation constrained. Both factors vary across the scenarios resulting in no one scenario necessarily seeing higher constraint costs than another.
- 1.16 This methodology describes the process and there is a high level process map in paragraph 2.1. Appendix B contains the SRF template; Appendix C is the cost checking process; and Appendix D is the form of the NOA report.
- 1.17 In accordance with Standard Licence Condition C27, the ESO has sought the input of stakeholders. Appendix E includes a summary of any views that the ESO has not accommodated in producing this NOA report methodology.

## Differences between NOA and ETYS

- 1.18 The NOA process is the ESO's licence obligation as required by Electricity Transmission Standard Licence Condition C27 (The Network Options Assessment process and reporting requirements). Specifically, paragraphs 16 and 17 define the required contents of the NOA report, which are the ESO's best view of options for reinforcements for the national electricity transmission system together with alternatives and recommended options.
- 1.19 The Electricity Ten Year Statement (ETYS) is the ESO's licence obligation as required by Electricity Transmission Standard Licence Condition C11 (Production of information about the national electricity transmission system). Paragraph 3 defines ETYS's required contents which are the ESO's best view of the design and technical characteristics of the development of the national electricity transmission system and the system boundary transfer requirements.
- 1.20 In summary, ETYS describes technical aspects of the system and the system's development while NOA describes options for reinforcement to meet system needs.



## The methodology

- 1.21 The Network Options Assessment (NOA) process set out in Electricity Transmission Standard Licence Condition C27 facilitates the development of an efficient, coordinated and economical system of electricity transmission and the development of efficient interconnection capacity. This NOA report methodology has been developed in accordance with Standard Licence Condition C27.
- 1.22 This document defines the process by which the NOA is applied to the onshore and offshore electricity transmission system in GB. The process runs from identifying a future reinforcement need, to assessing available options to meet this need, to recommending and documenting the option(s) for further development. It also defines the process of assessing the suitability of recommended options for competition in onshore electricity transmission. This assessment is against criteria defined by Ofgem in their document Guidance on the Criteria for Competition<sup>3</sup>. The ESO identifies and evaluates alternative options such as those based around commercial arrangements or reduced-build options in addition to those provided by the TOs. Table 2.2 on page 17 covers these alternative options in more detail.
- 1.23 The ESO has engaged with the TOs to develop this methodology statement. Following publication of the NOA report, further stakeholder engagement is undertaken to inform the methodology statement for supporting subsequent NOA reports.
- 1.24 As background information changes and new data is gained, for example in response to changing customer requirements, both the recommended options and their timing will be updated, driving timely progression of investment in the electricity transmission system.
- 1.25 The ESO engages stakeholders on the annual updates to the key forecast data used in this recommendation process, and shares the outputs from this process through the publication of the NOA report.
- 1.26 Transmission Licence Standard Condition C27 Paragraphs 16 and 17 set out the contents of the NOA report. Following the statutory consultation<sup>4</sup> on C27 changes held between 16 December 2019 and 20 January 2020, Ofgem announced its decision on 23 April 2020. This methodology takes account of the consultation decision though we had already applied the areas of the non-exhaustive list of types of options and assessing eligibility in previous versions of the methodology.

16. Each NOA report (including the initial NOA report) must be produced using the latest available data and in accordance with the methodology established pursuant to paragraph 8, and must, in respect of the financial year in which the report is published and each of the nine succeeding financial years:

(a) set out the licensee's best view of the options for Major National Electricity Transmission System Reinforcements and additional interconnector capacity that could meet the needs identified in the electricity ten year statement (ETYS) and facilitate the development of an efficient, co-ordinated and economical system of electricity transmission, including (but not limited to) any:

(i) options for Non Developer-Associated Offshore Wider Works;

(ii) options that involve construction of new transmission capacity;

(iii) options that do not involve, or involve minimal, construction of new transmission capacity;

(iv) options based on commercial arrangements with users to provide transmission services and balancing services;

(v) options that require liaison with a holder of a distribution licence on distribution system solutions;

<sup>3</sup> [https://www.ofgem.gov.uk/system/files/docs/2019/02/criteria\\_guidance.pdf](https://www.ofgem.gov.uk/system/files/docs/2019/02/criteria_guidance.pdf)

<sup>4</sup> <https://www.ofgem.gov.uk/publications-and-updates/decision-modifications-standard-condition-c27-electricity-transmission-licence>

- (vi) options recommended previously by the licensee to proceed but which have not been progressed by the transmission licensee to which the recommendation was given;
- (vii) options that cross the boundaries of two or more electricity licensee's transmission areas; and
- (viii) options suggested by other interested persons.
- (b) set out, in accordance with paragraph 17, the licensee's best view of the relative suitability of each option (or combination of options) set out pursuant to paragraph 16(a), for facilitating the development of an efficient, co-ordinated and economical system of electricity transmission;
- (c) set out the licensee's recommendations on which, if any, of the options set out pursuant to paragraph 16(a), should be developed further to facilitate the development of an efficient, co-ordinated and economical system of electricity transmission;
- (d) set out the licensee's best view of which, if any, of the options recommended pursuant to paragraph 16(c) comprise assets some or all of which satisfy the criteria in the Guidance on the Criteria for Competition, being a document of that name issued by the Authority and updated by the Authority from time to time, following consultation;
- (e) set out the licensee's best view of which, if any, connections (or modifications to existing connections) which arise from applications made for the purposes of standard condition C8 (Requirement to offer terms), comprise assets some or all of which satisfy the criteria in the Guidance on the Criteria for Competition, being a document of that name issued by the Authority and updated by the Authority from time to time, following consultation;
- (f) be consistent with the ETYS and where possible align with the Ten Year Network Development Plan as defined in standard condition C11 (Production of information about the national electricity transmission system), in the event of any material misalignment therewith, set out an explanation of the difference and any associated implications; and
- (g) have regard to interactions with existing agreements with parties in respect of developing the national electricity transmission system and changes in system requirements.
17. The licensee's best view, set out pursuant to paragraph 16(b), must include (but need not be limited to) the licensee's assessment of the impact of different options on the national electricity transmission system and the licensee's ability to co-ordinate and direct the flow of electricity onto and over the national electricity transmission system in an efficient, economic and co-ordinated manner.

- 1.27 The ESO considers *interested persons* to be parties who propose options that have a demonstrable benefit into the process but perhaps cannot do the analysis or studies. Interested persons can approach the ESO using the [noa@nationalgrideso.com](mailto:noa@nationalgrideso.com) mailbox.
- 1.28 References to 'weeks' in the NOA report methodology are to calendar weeks as defined in ISO 8601. Week 1 is at the start of January and is the same as the system used the Grid Code OC2.
- 1.29 This methodology includes the ESO process for High Voltage Management and ESO process for Stability Management in a combined section.
- 1.30 The ESO continually reviews the operability requirements of the transmission network. Where it finds a new need that competitive services may meet, it develops a pathfinder project to test the need, the possible approaches, market engagement and interest.

## Major National Electricity Transmission System Reinforcements

- 1.31 Standard Licence Condition C27 refers to the term Major National Electricity System Reinforcements for the purpose of this NOA report methodology statement. The definition has been agreed from consultation with the onshore TOs and the Authority (Ofgem) as:

Major National Electricity Transmission System Reinforcements are defined by the ESO to consist of a *project or projects in development to deliver additional boundary capacity or alternative system benefits as identified in the Electricity Ten Year Statement or equivalent document.*

- 1.32 The intention of this definition is to maximise transparency in the investment decisions affecting the National Electricity Transmission System while omitting schemes that do not provide wider system benefits. Such as schemes for a user connection or to improve system reliability.

## Eligibility criteria for projects for inclusion / exclusion

- 1.33 The NOA report presents projects as options to reinforce the wider network that are defined by Major National Electricity Transmission System Reinforcements (see definition above).
- 1.34 The ESO provides a summary justification for any projects that are excluded from detailed NOA analysis.
- 1.35 Once a Strategic Wider Work (SWW) Needs Case has been approved by Ofgem, the option is excluded from the NOA analysis although the report refers to it and it is included in the baseline. This is due to it being managed through the separate SWW process. Ofgem have agreed the approach of excluding options where they have already agreed the SWW Needs Case. The NOA report will include analysis of options under construction that are funded through the incremental wider works (IWW) mechanism.

## Roles and responsibilities of ESO and TOs

- 1.36 The ESO role and responsibilities are based around its overview of the network requirements. Specific role areas are as follows:
- analysis of UK FES data
  - devising and developing options including but not limited to operational options, commercial agreements and Offshore Wider Works (OWW) as well as early development of options (see section 7)
  - reviewing any option recommended in a previous NOA to proceed but which have not been progressed by the transmission licensee to which the recommendation was given
  - identifying boundary transfer requirements and publishing SRFs
  - verification studies of some boundary analysis performed by the TOs to corroborate the TOs' analysis
  - review of reinforcement options and their cost estimates that the TOs propose
  - assessment of outages and other system access availability that might affect the options' Earliest in Service Dates (EISD)
  - running cost-benefit analysis studies
  - recommending options for further development
  - assessing eligibility for competition
  - advise on the performance of boundary reinforcement proposals in the cost-benefit analysis to facilitate further option development by the TOs
  - providing an explanation of the NOA Committee recommendations
  - recording details if a TO does not follow a NOA recommendation



- producing and publishing the NOA report.
- 1.37 The TOs' roles and responsibilities include:
- technical analysis of boundary capabilities of the base network and uplifts from reinforcement options
  - proposing and developing reinforcement options and reduced-build options and providing their technical information to the ESO
  - cost information for options
  - outage and system access requirements for options
  - environmental information for options
  - consents and deliverability information for options
  - EISD of options
  - verification studies of some boundary analysis performed by the ESO to corroborate the ESO's analysis of alternative options
  - stakeholder engagement (following review of draft outputs of the NOA outcome)
  - community engagement
  - review of the draft NOA report and appendices relating to TO options.

### Stakeholder consultation

- 1.38 The ESO has consulted with the TOs and Ofgem whilst preparing this NOA report methodology.
- 1.39 The key consultation areas are the NOA methodology, form of the NOA report and the NOA report outputs and contents.
- 1.40 This section shows the timescales for the ESO's consultation of stakeholders during the period of writing the NOA report.

### Methodology review

- 1.41 The ESO seeks stakeholder views annually for consideration and where appropriate implementation before the NOA process starts its annual cycle.
- 1.42 Following the final publication of the NOA report, the ESO undertakes an internal review of the NOA process. This is completed within 18 weeks of the publication of the NOA report with the publication of an updated NOA methodology. This is then open for stakeholders' consultation where comments/feedback are invited. The consultation will close six weeks after the methodology is published for consultation. The ESO considers these comments for a revised NOA methodology and submits the methodology to Ofgem by 1 August of that year.
- 1.43 The ESO seeks approval from the Authority (Ofgem) on the NOA report methodology and form of the NOA report as part of the annual stakeholder engagement process.

### Report output

- 1.44 The ESO makes available selected parts of the pre-release NOA report to key stakeholders, particularly the relevant TOs, on a bilateral discussion basis to ensure confidentiality obligations. This is as the NOA report is being written based on assessment data, particularly economic data, becoming available. These discussions will occur as results become available and the report is being drafted.
- 1.45 Further key stakeholder engagement occurs with release of drafts of the NOA report, three weeks ahead of publication. This provides a final opportunity for stakeholders to comment on the NOA report and raise any significant concerns. When a stakeholder expresses concern with the conclusions of the report, a comment is incorporated in the relevant section(s).

## Provision of information

### Engagement with interested parties to share relevant information and how that information will be used to review and revise the NOA methodology

- 1.46 The NOA methodology and NOA report adequately protects any confidential information provided by stakeholders or service providers, for example, balancing services contracts. For this reason, this methodology seeks to be as open and transparent as possible to withstand scrutiny and provide confidence in its outcomes, while maintaining confidentiality where necessary.
- 1.47 In accordance with Licence Condition C27 Part C, the ESO provides information to electricity transmission licensees, interconnector developers and to the Authority (Ofgem) if requested to do so. The ESO will assist TOs with cost-benefit analysis for SWW Needs Cases. Where appropriate the ESO can use the NOA results as part of a SWW initial Needs Case with the agreement of the relevant TO(s).

### Future developments

- 1.48 The ESO expects the following changes and developments in the NOA report methodology and process as it evolves:
- Building on the pathfinding projects to test distribution solutions as NOA options including identifying non-MW requirements and the necessary cost-benefit analysis methodology.
  - Further refinement of the process for ESO-led options building on our experience.
  - Modification of the process for assessing eligibility for competition taking into account developments in the legislative framework and our experience with assessments to date.
  - Probabilistic tools that would facilitate:
    - i. Simulation analysis of full year network operation with variation in generation and demand profiles to identify both common and infrequent problems.
    - ii. Representation of typical operational optimisation actions such as control of power flow controllable devices (e.g., Quad Boosters (QBs) and other similar Flexible AC Transmission System (FACTS) devices)
    - iii. Automation of study set-up and contingency analysis
    - iv. Automated data manipulation and results handling and filtering
    - v. Continuous assessment of individual circuit parameters instead of boundary representation.

Our current work led to a thermal probabilistic case study to investigate the concept that aims to assess the viability of using probabilistic tools for thermal studies in the year 2019. This was published in March 2019. Having gained experience with thermal studies, which includes performance levels and validation, we envisage voltage and any other elements would follow in the subsequent two years.

We've been discussing with Ofgem about how suitable the LWR approach is for the NOA. In response to Ofgem's approval letter for the 2019/20 NOA methodology, we undertook a NIA project to review current transmission investment planning practices worldwide and assess the best decision making approach to planning under uncertainty. As part of this, we engaged the University of Melbourne to investigate the matter and advise us. They concluded that LWR is the best approach and suggested some refinements. These are to vary the scenario weighting to test how stable recommendations are within the solution space. This will work in concert with the implied probabilities that presented to the NOA Committee. We will continue to develop and test the suitability of this approach over the next year with the aim of including it in the next methodology.



# 2

## The NOA report process



## Overview of the NOA report process

2.1. Figure 2.1 gives an overview of the NOA report process. This methodology describes how the ESO, working with the TOs, carries out these activities.



Figure 2.1 Overview of the NOA report process

### Collect input

#### Updated Future Energy Scenarios (FES)

- 2.2. The relevant set of scenarios as required by Electricity Transmission Standard Licence Condition C11, is used as the basis for each annual round of analysis. These provide self-consistent generation and demand scenarios which extend to 2050. The FES document is consulted upon widely and published each year as part of a parallel process.
- 2.3. The NOA process utilises the scenarios as well as the contracted position to form the background for which studies and analysis is carried out. The total number of scenarios is subject to change depending on stakeholder feedback received through the FES consultation process. In the event of any change, the rationale is described and presented within the FES Stakeholder Feedback Document<sup>5</sup> that is published each year.
- 2.4. FES 2020 reflects the new UK net zero emissions target for 2050 and, as a result, is based on the following new scenario framework, with the last three achieving net zero by 2050:
- Steady Progression
  - System Transformation
  - Consumer Transformation
  - Leading the Way
- 2.5. The scenarios will continue to reflect a mix of technology options, taking account of the rapid changes in the energy industry, markets and consumer behaviour. Security of supply standards for both gas and electricity are achieved across all the scenarios.
- 2.6. The FES Scenarios are created by using a mix of data sources, including feedback from the FES consultation process. The scenario demands are then adjusted to match the metered average cold spell (ACS)<sup>6</sup> corrected actual outturns against which generation is applied to ensure security of supply can be met.

<sup>5</sup> See <http://fes.nationalgrid.com/media/1457/stakeholder-feedback-document-2020.pdf> for the FES Stakeholder Feedback Document and, for more general FES information, on our website <http://fes.nationalgrid.com>.

<sup>6</sup> The average cold spell (ACS) is defined as a particular combination of weather elements which give rise to a level of peak demand within a financial year (1 April to 31 March) which has a 50% chance of being exceeded as a result of weather variation alone.

- 2.7. Using regionally metered data, the “ACS adjusted scenario demands” are split proportionally around GB.
- 2.8. Based on the FES, there will be instances in the future where the available output of zero marginal cost generation such as nuclear and renewables will exceed demand, available storage and interconnection capacity. In these cases, the NOA economic model must choose which electricity source to be out of merit (referred to as ‘curtailment’ in the NOA economic model). We have set a merit order for zero marginal cost generation that aligns with the assumed subsidy level for each technology type. For example, onshore wind generation will be out of merit before offshore wind generation as it is assumed that offshore wind receives greater subsidies. There is currently no distinction made between different plants within a technology type and therefore if a technology is partially out of merit then the model will reduce the output of all plants within that technology type by the same factor.

### Sensitivities

- 2.9. Sensitivities are used to enrich the analysis for particular boundaries to ensure that relevant boundary issues are captured, such as the sensitivity of boundary capability by the connection of particular large generator or interconnector power flow condition. The ESO and TOs use a Joint Planning Committee subgroup as appropriate to coordinate sensitivities. This allows regional variations in generation activity and anticipated demand levels that still meet the scenario objectives to be appropriately considered.
- 2.10. For example, the contracted generation background on a national basis far exceeds the boundary requirements under the four main scenarios, but on a local basis, the possibility of the contracted generation occurring is credible and there is a need to ensure that we are able to meet customer requirements. A “one in, one out” rule is applied: any generation added in a region of concern is counter-balanced by the removal of a generation project of similar fuel type elsewhere to ensure that the scenario is kept whole in terms of the proportion of each generation type. This effectively creates sensitivities that still meet the underlying assumptions of the main scenarios but accounts for local sensitivities to the location of generation.
- 2.11. The inclusion of a local contracted scenario generally forms a high local generation case and allows the maximum regret associated with inefficient congestion costs to be assessed. In order to ensure that the maximum regret associated with inefficient financing costs and increased risk of asset stranding is assessed; a low generation scenario where no new local generation connects is also considered. This is particularly important where the breadth of scenarios considered do not include a low generation case.
- 2.12. Interconnectors to Europe give rise to significant swings of power flows on the network due to their size and because they can act as both a generator (when importing energy into GB) and demand (when exporting energy out of GB). For example, when interconnectors in the South East are exporting to mainland Europe, this changes the loading on the transmission circuits in and around London and hence creates different boundary capabilities.
- 2.13. The ESO models interconnector power flows from economic simulation using a market model of forecast energy prices for GB and European markets. The interconnector market model was improved for 2016 and now covers full-year European market operation. The results of the market model are then used to inform which sensitivities are required for boundary capability modelling. Sensitivities may be eliminated for unlikely interconnector flow scenarios.
- 2.14. The ESO and TOs extend sensitivities studies further to test credible conditions that may cause constraints. FES data tends to produce boundary flows in one direction, such as north

to south. In some circumstances, flows may be reversed. The ESO develops relevant sensitivities in consultation with stakeholders to produce boundary capabilities for these sensitivity cases.

### Interconnectors

- 2.15. For the NOA for Interconnectors (NOA IC), the ESO undertakes analysis to assess and provide a view on the optimum level of interconnection to other European markets. The markets considered are Belgium, Denmark, France, Germany, Ireland (the combined market of Northern Ireland and the Republic of Ireland), The Netherlands and Norway. The NOA IC process will use the output from the 2020/21 NOA as the baseline network reinforcement assumptions. The proposed NOA IC approach for 2020/21 is presented in the NOA IC methodology which can be found in Section 3 of this document.
- 2.16. The main benefits of the potential further interconnection analysed will be consumer, producer and interconnector welfare benefit for GB and Europe, while costs captured will include locational impacts on the GB transmission system and capital expenditure of interconnectors and associated network reinforcements. The ESO anticipates the market will respond to this intelligence with potential projects aligned with the optimum level of interconnection recommended by the ESO.
- 2.17. The output from the NOA IC process will be presented as a chapter in the NOA report and hence be published in late January 2020.

### Offshore Wider Works (OWW)

- 2.18. The ESO has written the NOA report methodology so that it treats all options for system reinforcement fairly. These options can include OWW and alternative options.
- 2.19. The licence condition gives the ESO the duty to devise and develop OWW. The ESO has written a methodology to explain how it develops OWW up to the point that it can use the options in its economic analysis. It has been published for consultation in April 2017. This methodology is the ESO Process for OWW and covers both Developer Associated and Non Developer Associated works and can be found in Section 5 of this document.

### Latest version of National Electricity Transmission System Security and Quality of Supply Standard (NETS SQSS)

- 2.20. The present Ofgem approved version 2.4 (applying from 1 April 2019) of the National Electricity Transmission System Security and Quality of Supply Standard (NETS SQSS) is used for each annual update.

## Identify future transmission boundary capability requirements

### National generation and demand scenarios

- 2.21. For every boundary, the future capability required under each scenario and sensitivity is calculated by the application of the NETS SQSS. The network at peak system demand is used to outline the minimum required transmission capability for both the Security and Economy criteria set out in the NETS SQSS.
- 2.22. The Security criterion is intended to ensure that demand can be supplied securely, without reliance on intermittent generators or imports from interconnectors in accordance with NETS SQSS section C.3.2. The level of contribution from the remaining generators is established in



accordance with the NETS SQSS for assessing the ACS peak demand<sup>7</sup>. Further explanation can be found in appendices C and D of the NETS SQSS. To investigate the system against the Security criterion, the ESO and TOs identify key network contingencies (system faults) that test the system's robustness. The ESO and TOs do this by using operational experience from the current year and interpreting this in terms of network contingencies. These are not only used directly in studies but also used to identify trends or common factors and applied in the NOA report analysis to ensure that TO options do not exacerbate these operational issues. This may lead to investment recommendations.

- 2.23. The Economy criterion is a pseudo cost-benefit study and ensures sufficient capability is built to allow the transmission of intermittent generation to main load centres. Generation is scaled to meet the required demand level. Further details can be found in appendices E and F of the NETS SQSS.
- 2.24. The NETS SQSS also includes a number of other areas which have to be considered to ensure the development of an economic and efficient transmission system. Beyond the criteria above, it is necessary to:
- Ensure adequate voltage and stability margins for year-round operation.
  - Ensure reasonable access to the transmission system for essential maintenance outages.
- 2.25. The ESO uses the scenarios and the criteria stated in the NETS SQSS to produce the future transmission capability requirements by using an in-house tool called 'Peak Y'. The ESO then passes these capability requirements to the TOs to identify future transmission options which are described in the following section.
- 2.26. The ESO is investigating the use of probabilistic tools to enhance the year-round assessment by incorporating background conditions which ought to reasonably rise in the course of the year. These conditions include demand cycles, typical power station operating regimes and typical planned outage patterns. They can assist to deliver year-round network analysis on system requirements, and further ensure that all sensitivities are covered. During our validation and/or shadowing of the NOA technical studies, we intend to use the probabilistic tool and techniques to assess the credibility of the background assumptions used and discuss where network capabilities are materially different when year-round conditions are considered. Experience gained from this year's work will be used to develop the tool for use in future NOA processes.

## Identify NOA options

- 2.27. At this stage, all the high level transmission options which may provide additional capability across a system boundary requiring reinforcement are identified (against economic and security criteria), including a review of any options considered in previous years. The NOA options are based around choices for example:
- an onshore route of conventional AC overhead line (OHL) or cable
  - an onshore route of (High Voltage Direct Current) HVDC
  - OWW options, such as integration between offshore generation stations.

---

<sup>7</sup> Average Cold Spell Peak Demand is defined as unrestricted transmission peak demand including losses, excluding station demand and exports. No pumping demand at pumped storage stations is assumed to occur at peak times. Please note that other related documents may have different definitions of peak demand, e.g. National Grid's 'Winter Outlook Report' quotes restricted demands and 'Future Energy Scenarios' quotes GB peak demand (end-users) demands.

- 2.28. Variations on each of these choices may be presented where there are significant differences in options, for instance between different OHL routes where they could provide very different risks and costs.
- 2.29. In response to the data on boundary capabilities and requirements, TOs identify and develop multiple credible options that deliver the potentially required boundary capabilities. The ESO produces and circulates the SRF Part A to the TOs. In response to Part A, TOs provide high level details of credible reinforcement options that are expected to satisfy the requirement. These options could be subsea links as well as onshore. Appendix D of this document provides detailed information about the SRF template. The SRF is split into six parts with a guideline on when the TO is required to complete and return each part.

*Table 2. 1 Description of the parts of the SRF template and when the TOs return them*

SRF Part	Description	When TOs SRF part is returned
A	Boundary requirement and capability	Mid-August (draft) Mid-September (final)
B	TO proposed options	Mid-August (draft) Mid-September (final)
C	Outages requirements	Mid-August (draft) Mid-September (final)
D	Studied option combinations and their impacts on the network	Mid-September
E	Options' costs	Mid-September
F	Publication information	Late October

The ESO has the opportunity to suggest concepts to the TOs for options to achieve the boundary requirements.

- 2.30. The ESO considers options for Non Developer Associated Offshore Wider Works (NDAOWW) which would deliver offshore reinforcements capable of providing the desired improvement in a boundary capability. The ESO continues with the early development of NDAOWW in accordance with Standard Licence Condition C27 Part D. This is to provide high level initial inputs to the cost-benefit analysis. To achieve this, the ESO forms a view on the technical outline and estimates the capital costs of the NDAOWW. As it is an initial and desk top exercise the capital cost estimates are likely to change significantly as the option starts to mature with further evaluation. The ESO liaises with the relevant TOs in the development of NDAOWW options.
- 2.31. The options that the TOs provide are listed and described in the NOA report along with ESO alternative options such as operational options. Each option's description includes the boundary that the option relieves, categorising the option into 'build', 'reduced-build' or 'operational' and a technical outline. The option description includes any associated aspects such as the nature of the area affected, related network changes etc. The ESO undertakes pathfinding projects to trial analysis of additional system needs and to include options from non-TO sources. Where relevant the ESO will include any applicable options in the economic analysis.

- 2.32. As part of the process to identify future transmission options, the ESO will develop alternative options with collaboration with the relevant TO (and the relevant affected parties if applicable). The ESO will provide information about network benefit of proposed alternative options and identify regions that might benefit from alternative options. Table 2.2 provides examples of alternative options. The TOs will have the opportunity to shadow the analysis performed by the ESO in their relevant networks. The ESO and TOs will agree a detailed assessment methodology appropriate to each option. To facilitate the development of these options, the TOs are expected to provide network information such as limiting trips and components, existing communication and control assets, and information on feasibility of alternative running arrangements.
- 2.33. It is recognised that as options develop, their level of detail increases. In the early stages, alternative options developed by the ESO will be high level options based on the best available information and will not assume availability of market data. The assumptions for each option will be agreed with the relevant TO while developing the option. The assumptions regarding EISD, required infrastructure, cost and effectiveness will vary depending on the studied region. Similarly, 'build' and 'reduced-build' options at a very early development stage might lack detail due to uncertainty in detailed project design such as land and consents requirements.
- 2.34. If the alternative option proves beneficial in the NOA cost-benefit analysis, the ESO will investigate the market to further develop the options. The ESO will use its existing pathfinder projects, or establish new pathfinders if necessary, to perform more detailed analysis to deliver these options. The ESO will share details of the technical and economic assessment approach with TOs/DNOs/Third parties as we develop the pathfinders. The TOs, DNOs, third parties will collaborate with the ESO to undertake technical analysis of relevant solutions/options to confirm their effectiveness as well as to determine any works required on the TO/DNO network to facilitate these solutions. The TOs, DNOs will also provide the ESO with details of associated costs and programme details for TO/ DNO works.
- 2.35. All TOs return the draft SRF Parts A and B in mid-August and the final version in mid-September. The timing is to support the ESO's verification studies and cost checking process. All TOs provide draft Part C in mid-August and final Parts C to E in mid-September. These form the key inputs to the cost-benefit analysis process. Part F is the means for the TOs to advise the ESO of the descriptions of the options to be published in the NOA report. The exact date is agreed between the ESO and the TOs for the year's programme for the ETYS and NOA.
- 2.36. Where an option affects an adjacent TO, the TOs and ESO coordinate their views on the reinforcement options and produce an agreed set of options by Week 32. The ESO uses the agreed set of options in its economic analysis and might use the options in its verification studies. If there is no agreement, the ESO forms a view on which options it assesses.
- 2.37. Once the TOs have returned the SRF Part A to E the ESO reviews the data and understands the costs by discussing them with the TOs. Through engagement, the ESO presents the data that it plans to use in the economic studies.
- 2.38. The ESO and TOs agree the combinations of options that the ESO will use in the cost-benefit analysis.
- 2.39. A non-exhaustive list of potential transmission solutions is presented in Table 2. 2. A wide range of options is encouraged including, where relevant, any innovative solutions and options suggested by other interested persons.



Table 2. 2 Potential transmission solutions

Category	NOA option	Nature of constraint			
		Thermal	Voltage	Stability	Fault Levels
Operational Options	Availability contract ( <i>contract to make generation available, capped, more flexible and so on to suit constraint management</i> )	✓	✓	✓	
	Reactive demand reduction ( <i>this could ease voltage constraints</i> )		✓		
	Enhanced generator reactive range through reactive markets ( <i>generators contracted to provide reactive capability beyond the range obliged under the codes</i> )		✓	✓	
		✓	✓		
	Automatic MW redistribution ( <i>Contracted for certain boundary transfers and faults</i> ). For example, contracted services from Demand side, generation deload/intertrip, storage charge/discharge	✓	✓	✓	
	Generation advanced control systems ( <i>such as faster exciters which improves transient stability</i> )		✓	✓	
Alternative Options	Co-ordinated Quadrature Booster (QB) Schemes ( <i>automatic schemes to optimise existing QBs</i> )	✓	✓		
	Automatic switching schemes for alternative running arrangements ( <i>automatic schemes that open or close selected circuit breakers to reconfigure substations on a planned basis for recognised faults</i> )	✓	✓	✓	✓
	Dynamic ratings ( <i>circuits monitored automatically for their thermal and hence rating capability</i> )	✓			
Reduced-build Options	Addition to existing assets of fast switching equipment for reactive compensation ( <i>a scheme that switches in/out compensation in response to voltage levels which are likely to change post-fault</i> )		✓	✓	
	Protection changes ( <i>faster protection can help stability limits while thermal capabilities might be raised by replacing protection apparatus such as current transformers (CTs)</i> )	✓		✓	
	HVDC de-load Scheme ( <i>reduces the transfer of an HVDC Intralink either automatically following trips or as per control room instruction</i> )	✓	✓	✓	
	'Hot-wiring' overhead lines ( <i>re-tensioning OHLs so that they sag less, insulator adjustment and ground works to allow greater loading which in effect increases their ratings</i> )	✓			
Build Options		✓	✓		
	Overhead line re-conductoring or cable replacement ( <i>replacing the conductors on existing routes with ones with a higher rating</i> )	✓			
	Reactive compensation in shunt or series arrangements (MSC, SVC, reactors). <i>Shunt compensation improves voltage</i>		✓	✓	

Category	NOA option	Nature of constraint			
		Thermal	Voltage	Stability	Fault Levels
	<i>performance and relieves that type of constraint. Series compensation lowers series impedance which improves stability and reduces voltage drop.</i>				
	Switchgear replacement (to improve thermal capability or fault level rating which in turn provides more flexibility in system operation and configuration. This would be used to optimise flows and hence boundary transfer capability).	✓			✓
	OHL reconfiguration (turn-in works at substations)	✓	✓	✓	
	Upgrading of circuits (for higher voltage levels)	✓	✓	✓	
	Power flow control devices (a type of Flexible AC Transmission System device that can be used to alter power flows over a circuit)	✓	✓	✓	
	New build (HVAC/HVDC) – new plant on existing or new routes.	✓	✓	✓	✓

- 2.40. It is intended that the range of options identified has some breadth and includes both small-scale reinforcements with short lead-times as well as larger-scale alternative reinforcements which are likely to have longer lead-times. The ESO applies a sense check in conjunction with the TOs and builds an understanding of the options and their practicalities. In this way, the ESO narrows down the options whilst allowing assessment of the most beneficial solution for consumers. Other than the application of economic tools and techniques, to refine a shortlist of options or identify a potential recommended option, the ESO relies on the TO for deliverability, planning and environmental factors. The ESO leads on operability and offshore integration matters ahead of the cost-benefit analysis.
- 2.41. In checking for the suitability of an option, the ESO reviews options for their operability and their effect on the wider system. As a result, the ESO checks for system access, ease of operation and the ability to adhere to operational policy and national standards. For system access, this means delivery of the option and the ability to manage outages to deliver future capital works and maintenance activities. In and affecting their areas, the TOs undertake part of this review of options in conjunction with the ESO. Because of their scale and complexity, some options may need more in-depth study work and involve an iterative approach with increasing detail added between NOA reports.

### Basis for the cost estimate provided for each option

- 2.42. The forecast cost is a central best view. By Week 30, the TOs and ESO agree each year the cost basis to be used for NOA analysis. The information that will have to be agreed includes but is not limited to:
- price base, that is the financial year of the prices and should be current year prices.
  - annual expenditure profile reflecting the options' earliest in service dates.
  - any major risks for options costed appropriately.
  - delay costs.

- the TO's Weighted Average Cost of Capital (WACC).
- 2.43. The TOs provide the individual elements of the investments that provide incremental capability.
- 2.44. For consistency of assessment across all options, the TOs provide all relevant cost information in the current price base.

### Environmental impacts and risks of options

- 2.45. Using the SRF the TOs provide views on the environmental impact of the options that they have proposed. This includes consideration of the environmental effects on the practicality of implementing each option.
- 2.46. As the TOs design and develop their options, their understanding of the environmental impacts of options improves. The more mature an option, its impact on the environment is better understood. Where appropriate, the TO indicates options that are relatively immature, which helps to highlight where the environmental impact needs further development. The ESO gives a similar indication on options that it is leading, such as OWW. As the NOA is the first step in an economic analysis of the need for reinforcement of the national electricity transmission system, it is not intended to provide an environmental assessment of those options. The TO will take any appropriate and timely environmental considerations into account as part of their investment process and according to relevant planning laws.
- 2.47. Different planning legislation and frameworks apply in Scotland from those in England and Wales. Where reinforcements cross more than one planning framework, this is highlighted in the NOA report together with any implications. The TOs hold the specialist knowledge for planning and consents and provide the commentary.

### Checks of the costs that the TOs submit

- 2.48. The ESO reviews the costs that the TOs submit with their options and checks that they are reasonable. This is to help ensure the highest quality data goes into the NOA report process. The TOs use SRF Part E to submit the costs which are also used to assess eligibility for competition. Consenting costs are submitted through the same template but are made distinct from the construction costs.
- 2.49. The ESO checks the costs that the TOs submit against a range of costs for plant and equipment that the ESO has gained from recent experience. If any costs are outside of the range, the ESO discusses the costs with the TO. If following discussions the ESO still believes that the costs are outside of the expected range and will unduly affect the economic analysis, the ESO can omit the option from the economic analysis.
- 2.50. The ESO performed the costs check for the first time as part of the 2017/18 NOA report. The process the ESO uses for the costs check is described by appendix C. This process takes into account experience gained with previous checks.

### Build GB model

- 2.51. The TOs submit power system models to the ESO for each year being modelled. The ESO uses these along with FES data to produce complete power system models of the GB network and shares these for analysis. Additional models and modelling information for different scenarios and network options are also submitted such that the ESO and TOs have adequate information to carry out the necessary option analysis.



## Boundary capability assessment for options

- 2.52. The ESO and TOs complete boundary capability assessment studies to feed into the cost-benefit analysis process. The TOs submit the results of their boundary studies for their own areas with their SRFs. TOs study neighbouring areas to ensure TO coordination between base capabilities and options' uplifts for those that cross TO areas. The ESO also performs studies of some of the same boundaries as the TO for the purpose of verification. For studies prior to the new SRF submission, the ESO studies reinforcements using information that the TO submitted the previous year. This assumes that many reinforcement proposals are the same or very similar from one year to the next. The TO will endeavour to provide any updates to the ESO on adjustments they make to their options that will allow the ESO to modify its studies. The ESO performs studies concurrently with the TOs to be able to perform a cross-check of some of the capability results, to the extent that the information on the options and any adjustments is available before the start of the economic analysis process. The ESO can ask the TOs for additional SRFs in the period June to August if it finds that its studies highlight a need for further reinforcement.
- 2.53. Thermal loading, voltage and stability boundary limitations are assessed to find the maximum boundary power transfer capability. The boundary capability is the greatest power transfer that can be achieved without breaching any NETS SQSS limitation. Variations in background to represent different network conditions, such as generation patterns or time of the year that may cause critical variations in boundary capability are assessed separately from the traditional winter peak studies.
- 2.54. In order to minimise unnecessary repetition whilst maintaining robustness, winter peak network analysis is carried out under the scenario that will stress the transmission system the most (in 2020 this will be the Leading the Way scenario). This scenario has the highest electrical load and generation and therefore gives us the required stress on the system to test our boundary capabilities. Where there are significant differences in network conditions, either between scenarios or in time, additional sensitivity analysis is undertaken where appropriate to understand any network capability impact. For the purposes of any stability analysis (where required), year-round demand conditions are considered. The secured events that are considered for these assessments are N-1-1, N-1 and N-D as appropriate in accordance with the NETS SQSS.
- 2.55. The analysis is done in accordance with the ETYS/NOA study guidelines which describes the constraint type, scenario, season and the years for the network assessment. The ETYS/NOA study guidelines are governed by the STC.
- 2.56. For the purpose of the boundary capability assessment, the baseline boundary conditions need to be altered to identify the maximum capability across the boundary. To make these changes, the generation and demand on either side of the boundary is scaled until the network cannot operate within the defined limits. The steady state flows across each of the boundary circuits prior to the secured event are summed to determine the maximum boundary capability.
- 2.57. The factors shown in Table 2. 3 below are identified for each transmission solution to provide a basis on which to perform cost-benefit analysis at the next stage.

Table 2. 3 Transmission solution factors

Factor	Definition										
Output(s)	The calculated impact of the transmission solution on the boundary capabilities of all boundaries, the impact on network security										
Lead-time	An assessment of the time required developing and delivering each transmission solution; this comprises an initial consideration of planning and deliverability issues, including dependencies on other projects. An assessment of the opportunity to advance and the risks of delay is incorporated.										
Cost	The forecast total cost for delivering the project, split to reflect the pre-construction and construction phases.										
Stage	The progress of the transmission solution through the development and delivery process. The stages are as follows:										
	<i>Project not started</i>										
	<i>Pre-construction</i>										
	<table border="1"> <tbody> <tr> <td><i>Scoping</i></td> <td>Identification of broad Needs Case and consideration of number of design and reinforcement options to solve boundary constraint issues.</td> </tr> <tr> <td><i>Optioneering</i></td> <td>The Needs Case is firm; a number of design options being developed so that a preferred design solution can be identified.</td> </tr> <tr> <td><i>Design/ development and consenting</i></td> <td>Designing the preferred solution into greater levels of detail and preparing for the planning process including public consultation and stakeholder engagement.</td> </tr> <tr> <td><i>Planning / consenting</i></td> <td>Continuing with public consultation and adjusting the design as required all the way through the planning application process.</td> </tr> <tr> <td><i>Consents approved</i></td> <td>Consents obtained but construction has not started</td> </tr> </tbody> </table>	<i>Scoping</i>	Identification of broad Needs Case and consideration of number of design and reinforcement options to solve boundary constraint issues.	<i>Optioneering</i>	The Needs Case is firm; a number of design options being developed so that a preferred design solution can be identified.	<i>Design/ development and consenting</i>	Designing the preferred solution into greater levels of detail and preparing for the planning process including public consultation and stakeholder engagement.	<i>Planning / consenting</i>	Continuing with public consultation and adjusting the design as required all the way through the planning application process.	<i>Consents approved</i>	Consents obtained but construction has not started
<i>Scoping</i>	Identification of broad Needs Case and consideration of number of design and reinforcement options to solve boundary constraint issues.										
<i>Optioneering</i>	The Needs Case is firm; a number of design options being developed so that a preferred design solution can be identified.										
<i>Design/ development and consenting</i>	Designing the preferred solution into greater levels of detail and preparing for the planning process including public consultation and stakeholder engagement.										
<i>Planning / consenting</i>	Continuing with public consultation and adjusting the design as required all the way through the planning application process.										
<i>Consents approved</i>	Consents obtained but construction has not started										
	<table border="1"> <tbody> <tr> <td><i>Construction</i></td> <td>Planning consent has been granted and the solution is under construction.</td> </tr> </tbody> </table>	<i>Construction</i>	Planning consent has been granted and the solution is under construction.								
<i>Construction</i>	Planning consent has been granted and the solution is under construction.										

- 2.58. In order to assess the lead-time risk described in Table 2. 3, the ESO will consider, for a project with significant consents and deliverability risks, both 'best view' and 'worst case' lead-times submitted by the TOs to establish the least regret for each likely project lead-time.
- 2.59. It is possible that alternative options are identified during each year and that the next iteration of the NOA process will need to consider these new developments alongside any updates to known transmission options, the scenarios or commercial assumptions.

- 2.60. If the TOs decide that there are insufficient options to cover all scenarios, they initiate further work to identify reinforcement options. The TOs aim for at least three options for each boundary requirement. The TOs can submit long-term conceptual options to ensure that there are enough options. The long-term conceptual options are high level and are developed only as far as their boundary transfer benefits and initial estimate of costs. Power system analysis is not conducted on the conceptual options.
- 2.61. Where there are boundaries affecting more than one TO, the TOs should arrange challenge and review meetings to determine the options for inclusion in the economic analysis and in the NOA report.
- 2.62. The TOs use their boundary capability results in the SRF Part D that they submit back to the ESO.
- 2.63. Where specific boundary capabilities are not provided for spring, summer, autumn or outage conditions the following winter adjustment factors shall be used.

#### Seasonal boundary capability scaling

Spring and autumn thermal	85%
Summer thermal	80%
Summer outage thermal	70%
Summer outage voltage	90%

- 2.64. The ESO leads on operational options in cooperation with the TOs. The economic analysis tool needs a MW value for the boundary capability which this analysis of operational options must provide. In addition, the ESO must provide ongoing costs for the economic analysis such as intertrip arming fees as well as any capital outlay such as the cost of designing/installing the intertrip.

## Cost-benefit analysis

### Introduction

- 2.65. Cost-benefit analysis compares forecast capital costs and monetised benefits over the project's life to inform this investment recommendation.
- 2.66. The NOA provides investment recommendations based on the Single Year Regret Decision Making process. If the ESO's NOA recommendation is to proceed and triggers an SWW Needs Case, the ESO will assist the TO to produce an SWW Needs Case by undertaking a more detailed cost-benefit analysis.
- 2.67. The purpose of the Single Year Regret Decision Making process is to inform investment recommendations regarding wider transmission works for the coming year. The main output of the process is a list of recommended wider works reinforcement options to proceed with or to delay in the next year. A secondary output is an indicative list of which options would be proposed at present if each of the scenarios were to turn out.
- 2.68. The methodology for SWW cost-benefit analysis follows the **Guidance on the Strategic Wider Works arrangements in the electricity transmission price control, RIIO-T1**

document published by Ofgem<sup>8</sup>. A Needs Case is submitted by the TO that proposes the option to the regulator, and which includes a cost-benefit analysis section that outlines the financial case for the option. The output of this process is a recommendation of an option for the option that is to be proceeded with.

### Cost-benefit analysis methodology

- 2.69. Since the number of options proposed for the transmission system is quite large the country is split into regions and each option is allocated to one of the regions. The cost-benefit analysis process for each region is conducted in isolation. The year in which each of the options outside the region that is being studied will be commissioned is fixed to a pre-determined value, which may vary by scenario. This is usually based upon the recommendations of the most recent NOA report. The size and extent of a region (that is where region dividing lines are drawn) may change from year to year. The criterion by which a region is defined is that an option may not appear in more than one region (this is to prevent an option being evaluated more than once, with the risk of two different answers).
- 2.70. All of the FES scenarios are considered; furthermore, it is usual for sensitivities to be considered as described previously. Each scenario is studied in isolation; the following description refers to the study of one scenario, the process is repeated (in parallel since there is no dependency) for the other scenarios. The process is an iterative process that involves adding a single reinforcement at a time and then evaluating the effect that this change has had on the constraint cost forecast.
- 2.71. To begin the process all proposed options within the region are disabled, the output of the model is analysed to determine which boundaries within the region require reinforcement and when the option is required, this simulation is referred to as the base case. This information is used to determine which option(s) should be evaluated first. The option that has been selected to be evaluated next is then activated in the constraint cost modelling tool (see Table 2.4 for a description) at its EISD. If a number of potential options have been identified as being candidates for the next option then this process must be repeated with each option in turn. There are now two sets of constraint cost forecasts, the base case and the reinforced case, which are compared using the Spackman<sup>9</sup> methodology.
- 2.72. It is assumed that each transmission asset is to have a 40-year asset life. Since the constraint cost modelling tool only forecasts for the next 20 years the constraint costs for each year after that are assumed to be identical to the final simulated year (note that this limitation occurs because the scenarios do not contain detailed ranking orders beyond 20 years). Constraint cost forecasts are discounted using HM Treasury's Social Time Preferential Rate (STPR) to convert the forecasts into present values. The capital cost for the option is amortised over the asset life using the prevalent WACC and discounted using the STPR. This value is added to the constraint cost forecast for the reinforced case. The present value of the base case is then compared to the present value of the reinforced case plus the amortised present value of the capital costs to give the net present value (NPV) for this option.
- 2.73. This cost-benefit analysis process is carried out in a separate comparison tool which also automatically calculates the NPVs if the option being evaluated were to be delayed by a number of years. This list of NPVs allows the optimum year for the option, for the current scenario, to be calculated. If a number of alternative candidate options have been identified,

---

<sup>8</sup> <https://www.ofgem.gov.uk/ofgem-publications/83945/guidanceonthestategicwiderworksarrangementsinriiot1.pdf>

<sup>9</sup> The Joint Regulators Group on behalf of UK's economic and competition regulators recommend a discounting approach that discounts all costs (including financing costs as calculated based on a Weighted Average Cost of Capital or WACC) and benefits at HM Treasury's Social Time Preference Rate (STPR). This is known as the Spackman approach.



then the option that has the earliest optimum year should usually be chosen. The chosen option is then added to the base case and another option is chosen for evaluation. The process is then repeated until further options produce a negative NPV (which would indicate that the capital cost of the option exceeds the saving in constraint costs). There may be an element of branching if it is not immediately obvious during the process which option should be chosen to be added to the base case at any given point.

- 2.74. The outcome of this process is a list of options, for the current region and scenario, and the optimum year for each. This is referred to as a 'reinforcement profile'.
- 2.75. Once the reinforcement profile for each scenario within a region has been determined the 'critical' options for that region may be chosen. The definition of a 'critical' option has some flexibility but the definition below must be considered.
- 2.76. An option's recommendation is critical if a decision to delay the option in the current year means that the optimum year, under any scenario or sensitivity, could no longer be met (note that outage availability may play a part in this decision).

### Constraint cost modelling tool

- 2.77. The constraint cost modelling tool is used to forecast the constraint costs for different network states and scenarios. The high-level assumptions and inputs used in the tool are outlined in Table 2. 4.

Table 2. 4 Assumptions and input data for the constraint cost modelling tool

Input Data	Current Source	Description
Fuel price forecasts	FES	20-year forecast, varies by scenario
Carbon price	FES	20-year forecast
Plant efficiencies and season availabilities	AFRY (historic)	
Plant bid and offer costs	Historic data	See Long-term Market and Network Constraint Modelling <sup>10</sup>
Renewable generation	AFRY (historic)	Wind, solar, and tidal profiles for zones around the UK
Demand data	FES	Annual peak and zonal demand
Demand profile	AFRY	Within year profiles
Maintenance outage patterns	Historic data	Maintenance outage durations by boundary
System boundary capabilities	Power system studies	See text
Reinforcement incremental capabilities	Power system studies	See text

<sup>10</sup> See <https://www.nationalgrideso.com/insights/network-options-assessment-noa>

- 2.78. The model is set to simulate 8 periods per day for 365 days per year and is set to simulate 20 years into the future. The year in which an option is commissioned can be varied. The primary output from the tool for the cost-benefit analysis process is the annual constraint forecast; there are further outputs that help the user identify which parts of the network require reinforcement.

## Selection of recommended option

- 2.79. At this point, all of the economic information available to assess the options is in place. The ESO then uses the Single Year Least Regret analysis methodology to identify the recommended option or combination of recommended options.

## Single year least regret decision making

- 2.80. The single year least regret methodology involves evaluating every permutation of the critical options in the first year (the year beginning in April following publication of the NOA report). For each critical option, there are two choices, either to proceed with the option for the next year or to delay the option by one year (that is do nothing). It is assumed that information will be revealed such that the optimal steps for a given scenario can be taken from year two onwards – so only the impact of decisions in the first year are evaluated. If there is more than one critical option in the region then the permutations of options increase; the number of permutations is equal to  $2^n$ , where n is the number of critical options.
- 2.81. Each of the permutations has a series of cost implications, these are either additional capital and constraint costs if the option were delayed (and further additional costs if the option were to be restarted at a later date) or inefficient financing costs if the project is proceeded with too early.
- 2.82. For each permutation and scenario combination the present value is calculated, taking into account operational and capital costs. For each scenario one of the permutations will have the lowest present value cost, this is set as a reference point against which all the other permutations for that scenario are compared. The regret cost is calculated as the difference between the present value of the permutation for a scenario and the present value that is lowest of all permutations for the scenario. This results in one permutation having a zero regret cost for each scenario.
- 2.83. The following section is a worked example of the least regret decision making process. Two options have been determined to be ‘critical’ in this region, the EISD for option 1 is 2020 and the EISD for option 2 is 2021. The optimum years for scenarios A, B and C are shown in Table 2. 5. Note that the scenarios are colour-coded; this is used for clarity in the following tables.

Table 2. 5 Example of optimum years for two critical reinforcements

Scenario	Option 1	Option 2
A	2020	2021
B	2020	2024
C	2027	N/A

Table 2. 6 Example decision tree

Permutation	Year 1 Recommendations	Completion Date	NPV	Regrets	Worst regret for each permutation
i	Proceed Option 1 & Delay Option 2	Option 1: 2020 Option 2: 2022	£149m	£51m	£51m
		Option 1: 2020 Option 2: 2024	£100m	£0m	
		Option 1: 2027 Option 2: Cancel	£145m	£5m	
ii	Delay Option 1 & Proceed Option 2	Option 1: 2021 Option 2: 2021	£98m	£102m	£102m
		Option 1: 2021 Option 2: 2024	£65m	£35m	
		Option 1: 2027 Option 2: Cancel	£140m	£10m	
iii	Proceed Option 1 & Proceed Option 2	Option 1: 2020 Option 2: 2021	£200m	£0m	£15m
		Option 1: 2020 Option 2: 2024	£98m	£2m	
		Option 1: 2027 Option 2: Cancel	£135m	£15m	
iv	Delay Option 1 & Delay Option 2	Option 1: 2021 Option 2: 2022	£47m	£153m	£153m
		Option 1: 2021 Option 2: 2024	£68m	£32m	
		Option 1: 2027 Option 2: Cancel	£150m	£0m	

2.84. Table 2. 6 is an example of a least regret decision tree, since there are two ‘critical’ options there are therefore four permutations. From Year 2 onwards for each of the permutations the options are commissioned in as close to the optimum year for each option for each scenario. For each scenario one of the four permutations is the optimum and therefore there is one £0m value of regret for each scenario. The table’s NPV column indicates the net present value for each of the permutations in each of the scenarios.

2.85. Studying Table 2. 6 shows us that it is largely scenarios A and C that are deciding the single year least worst regret. There is a large regret in scenario A from choosing any other

permutation than permutation 3 (at least £51m), and scenario C is the scenario that generates the maximum regret for permutation 3. If we calculate the implied probabilities for the decision to proceed with permutation 3 rather than 1 or 4 we find that the implied probabilities are roughly 16% and 9% for A vs. C respectively. This shows us that in order to make the same decision under expected NPV maximisation we would need to believe that A is at least 16% likely and C is less than 84% likely to choose 3 over 1, and A is at least 9% likely and C is less than 91% likely to choose 3 over 4. As an example, 16% implied probability for scenario A vs. C when considering 3 vs. 1 was found by solving the following equation:

$$200p + 135(1-p) > 149p + 145(1-p)$$

where p is the probability of scenario A and (1-p) is the probability of scenario C. It is worth noting that implied probabilities must be kept to two scenario comparisons for a single choice (i.e. 3 vs. 1) since expanding the scenario and permutation space would make the implied probabilities intractable to interpret.

- 2.86. The causes of the regret costs vary depending upon what the optimum year is for the reinforcement and scenario:
- If the option is delayed and therefore cannot meet the optimum year, then additional constraint costs will be incurred.
  - If the option is delayed unnecessarily then there will be additional delay costs.
  - If the option is proceeded with too early, then there will be inefficient financing costs.
  - If the option is proceeded with and is not needed, then the investment will have been wasted.
- 2.87. The regret costs for each permutation under all scenarios are then compared to find the greatest regret cost for each permutation. This is referred to as the worst regret cost. The permutation with the least 'worst regret' cost is chosen as the recommended option or combination of options to proceed in the coming year and appears in the report's investment recommendation. In the example shown above the least 'worst regret' permutation is to proceed with both options 1 and 2 which has a worst regret of £15m and is the least of the four permutations.
- 2.88. As the scenarios represent an envelope of credible outcomes it is possible that a reinforcement option is justified by just one scenario which doesn't always guarantee efficient and economic network planning if industry evolution were not to follow that particular scenario. In this event, the ESO would examine the single year regret analysis result to establish the drivers and then examine the scenario further. How we do this varies according to circumstances but an example would be considering the cost-benefit analysis's sensitivity to specific inputs. This in turn informs our view on the robustness of the outcome and thus whether to make a recommendation based upon this scenario. The ESO supports all the TOs in this manner to optioneer and develop their projects to minimise the cost such as reducing any frontloading of expenditure if there is doubt about the need for the reinforcement option or downgrading the importance of the investment completely. The ESO examines any sensitivity studies in the same way to ensure none skew the results unfairly. For example, if a change in policy were to occur after the publication of the FES document, significant amounts of generation in the scenarios may be affected and their connection may then be delayed or unlikely to go ahead. We would flag this kind of background update, and identify in the single scenario driven investments where this is likely to be creating a skewed outcome. The ESO is investigating the development of probabilistic tools to deliver year-round network analysis on thermal and voltage network requirements, and further ensure that all sensitivities are covered. However, this is at an early stage and not yet ready for use with the NOA.



## Process output

- 2.89. Following Single Year Regret analysis, for each region in the country a list of ‘critical’ options for the region is presented with the investment recommendation for each.
- 2.90. The ESO has introduced implied scenario weightings to provide additional insight into the single year regret analysis. The ESO does not assign probabilities to any of its scenarios, however it is useful to know what probability weights are consistent with the recommendations. This is particularly useful for options which are driven by a single scenario. The ESO identifies the scenario where the option brings the most benefit and the scenario where the option brings the least benefit. It then calculates the weightings between these two scenarios that would be required in order to justify the recommendation for investment in this option under expected net present value maximisation. This allows the ESO to reflect upon whether the implied probability of the driving scenario is reasonable to justify next year expenditure. For more information including examples, please see our NOA Methodology Review which can be found at [www.nationalgrideso.com/NOA](http://www.nationalgrideso.com/NOA).
- 2.91. The ESO has created the NOA Committee to challenge the single year regret recommendations. The Committee is designed to allow the ESO to review the investment recommendations that are marginal or risk being driven by a single scenario. This will seek to identify any ‘false-positive’ investment recommendations that could come about as a result of the single year regret process, and ensure that the single year regret analysis recommendations are justified. In addition, the Committee will ensure the recommendations are supported by the holistic needs of the system. The Committee consists ESO senior management who will challenge the robustness of the investment recommendations as well as provide holistic energy industry insight and take into account whole system needs to support or revise the marginal investment recommendations. Ofgem can also be present as observers to represent the consumers’ interests and provide regulatory oversight, as well as understand the driving factors behind recommendations. In preparation for the Committee meeting, the ESO will discuss the single year regret outputs with internal stakeholders and the TOs to ensure the final recommendations are robust. The TOs are invited to attend the NOA Committee to provide supporting evidence as the committee requires while maintaining the necessary commercial confidentiality.
- 2.92. The guiding principle behind the NOA committee is that, on the marginal decisions the Committee reviews, the members should advise the investment recommendation they believe is most prudent, on the balance of evidence. This means that they believe, on the balance of probabilities, the recommendation (to proceed or delay) is the best course of action for the GB consumer. This will take into consideration the many facets of the decision including, but not limited to: forecasted constraints in the scenario(s) advocating the option; the drivers behind the investment recommendation (e.g. specific generation build-up) and the latest market information on those drivers; what the regret is across the other scenarios; what next year’s expenditure is acquiring and what it will achieve (e.g. will the expenditure allow the TO to learn more about the option); what effect a delay decision will have on the earliest in service date (e.g. more than one year postponement in the earliest in service date); what the implied scenario weight of the decision is (that is what probability would have to be placed on the driving scenario to make the same decision under expected net present value maximisation); and wider system operability considerations including the availability of commercial solutions to congestion issues. The committee members should seek to have a risk-neutral outlook in their deliberations, that is they should seek to make decisions dispassionately, and on the balance of evidence, bearing in mind as much as possible the likelihood of future events.
- 2.93. After deliberation committee members will conclude on the marginal options. The Committee’s aim is to reach a consensus. The outcomes will be minuted and these minutes will show the rationale behind the recommendations as well as highlight the challenges

raised. The minutes will be made available to Ofgem and the TOs and published on the NOA webpage.

- 2.94. The ESO uses the output from the single year regret analysis for the recommendation on whether a reinforcement option should proceed under the England and Wales NDP framework.
- 2.95. If the investment signal triggers the TO's Needs Case, the ESO will assist the TO in undertaking a more detailed cost-benefit analysis. The ESO reconciles the economy and security results (in accordance with NETS SQSS Chapter 4) as mentioned previously in the section on sensitivities before making a final recommendation.
- 2.96. If a TO does not follow a NOA recommendation, it must inform the ESO at the earliest opportunity and tell the ESO about the effect on the option's EISD. If the TO has discretion over the change, it should fully involve the ESO in the decision process. The NOA Committee will monitor the process and the outcome.

### Cost bands

- 2.97. The ESO sorts reinforcement options with a 'Proceed' recommendation after economic analysis and connections into cost bands which it then includes in the NOA. The assumptions are that land costs are included in the costs but the cost of consents is excluded. The costs apply for new and separable elements only. Table 2. 7 shows the cost bands that have been agreed.

*Table 2. 7 Table of cost bands*

Cost bands
£100m - £500m
£500m - £1000m
£1000m - £1500m
£1500m - £2000m
Greater than £2000m

### Report drafting

- 2.98. The ESO drafts the NOA report but the responsibility for the content varies between the ESO and TOs. The form of the report is subject to consultation and also to Ofgem approval. Appendix D gives more detail on the form of the NOA report.
- 2.99. Chapters 3 and 4 cover the options and their analysis. The component parts of these chapters and the responsibilities for producing the material are in Table 2.8. Appendix D gives more detail on the form of the NOA report.

Table 2. 8 Areas of Responsibility

NOA report Options topic	Build options	Alternative options	Offshore	Comments
Options: Status of the option (scoping, optioneering, design, planning, construction)	TO	ESO/TO	ESO	
Options: Technical aspects – assets and equipment	TO	ESO/TO	ESO	
Options: Technical aspects – boundary capabilities	TO	ESO/TO	ESO/TO	
Options: Economic appraisal	ESO	ESO	ESO	Leads to investment recommendations for TOs
Options: Comparison of the options	ESO	ESO	ESO	
Options: Competition assessment	ESO	ESO	ESO	Includes competition criteria and how options were categorised

2.100. The report presents the relevant information to communicate the investment recommendations whilst maintaining appropriate commercial confidentiality. Information is therefore presented to demonstrate the relative benefits of options while protecting commercial confidentiality. This is in consultation with stakeholders. The ESO passes outputs to the TOs to support its view of investment recommendations.

2.101. Report drafting is undertaken in the period late July to January.

## Report publication

2.102. The ESO publishes the NOA report by 31 January of each year or as instructed otherwise by Ofgem.

2.103. On publication, the report is placed on the National Grid website in a PDF form that is widely readable by readily available software. The ESO also provides a copy on request and free of charge of the report to anyone who asks for one.

2.104. Standard Licence Condition C27 Paragraph 13 provides for delaying publication if the Authority (Ofgem) delay their approval of the NOA report methodology or form of NOA report.

2.105. The Licence Condition allows for the omission of sensitive information.



# 3

## Network Options Assessment for Interconnectors



## Overview

- 3.1 This chapter provides an overview of the aims of the NOA with respect to interconnectors and details the methodology which the ESO will adopt for the analysis and publication within the sixth NOA report (to be published by 31<sup>st</sup> January 2021).
- 3.2 Since the publication of the first NOA (2015/16), we have developed the NOA for Interconnector (NOA IC) methodology for each year. The developments have included:
- Use of our pan-European market model BID3
  - Modelling of Socio-Economic Welfare
  - Inclusion of modelling of GB network constraints
  - Use of the baseline network reinforcement assumptions from NOA as the starting point for the NOA IC analysis
- 3.3 We wish to continue to develop the NOA for Interconnector methodology. This chapter represents our latest thoughts. Our goal is to produce a NOA for Interconnectors analysis that continues to be of increasing value for our stakeholders.
- 3.4 The primary purpose of NOA IC is to provide a market and network assessment of the optimal level of interconnection capacity to GB. This is undertaken by evaluating the social economic welfare, that is the overall benefit to society of a particular option, as well as constraint costs and capital expenditure costs of both the interconnection capacity and network reinforcements.
- 3.5 To achieve this, NOA IC does not attempt to assess the viability of current or future projects: the final insights are largely independent of specific projects currently under development and NOA IC does not provide any project-specific results.
- 3.6 NOA IC currently only considers point to point interconnection between GB and potential European connecting countries. However the potential for multi-purpose interconnectors, or hybrid interconnectors, that may include connections to more than two countries and also incorporate connections to offshore windfarms in the North Sea are also being proposed by developers.
- 3.7 NOA IC 2020/21 remains focused on point to point interconnection, but we are keen to explore with stakeholders whether there is any value and also whether it is feasible for the ESO to evolve NOA IC so that subsequent iterations may quantify the potential benefits to GB consumers of a range of interconnection types. The ESO would welcome stakeholders views on this topic.

## Structure of this section

- 3.8 This section consists of the thirteen sub-sections listed below:
- **Key changes to 2020/21 methodology** - A summary of the major changes made to the NOA for Interconnector methodology for 2020/21.
  - **Key similarities to the 2019/20 methodology** - A summary of which areas of the methodology have remained the same from 2019/20 to 2020/21.
  - **Factors for the assessment of future interconnection** - A justification of the factors to be considered in determining whether additional capacity would be beneficial.
  - **Cost estimation for interconnection capacity** – The costs associated with an interconnector and how these will be calculated.
  - **Cost estimation for network reinforcement** – The costs associated with network reinforcements and how these will be calculated.
  - **Components of welfare benefits of interconnection** – This sub-section outlines the concept of Socio-Economic Welfare in relation to interconnection and the components of the calculation.



- **Constraint cost implications** – An outline of how interconnectors could impact the operational costs on the network.
- **BID3 model** – A description of the ESO's current market modelling capabilities.
- **Options included within the assessment** – A listing of the options that will be assessed within the modelling.
- **Interconnection assessment methodology** – A description of the method by which the ESO proposes to meet the aims of the NOA in relation to optimal interconnection capacity.
- **Further Output** – Additional results that may be of benefit to stakeholders.
- **Process Output** – How the NOA IC output will be delivered.

### Key changes for 2020/21 methodology

- 3.9 This year we will continue to improve the NOA for Interconnectors analysis by acting on feedback from our stakeholders.
- 3.10 We will refocus on providing additional value from the main iterative analysis on social economic welfare, capital costs and constraint costs, by drawing greater insights from the use of the European FES, which improve the quality and range of interconnector modelling that drives the NOA IC analysis, as well as improving the GB-specific constraint and network analysis.
- 3.11 We will continue to review the method used for setting the interconnector baseline level to ensure that the baseline level of interconnection represents a credible starting point for the analysis.

### Key similarities to 2019/20 methodology

- 3.12 We will continue to take into consideration the locational impacts on the GB transmission network in addition to the welfare and capital cost implications, and provide greater insight to our stakeholders of the effects of interconnection on the network.
- 3.13 We will continue to focus on Social Economic Welfare, capital costs and reinforcement costs.
- 3.14 We will use the output from the 2020/21 NOA as the baseline network reinforcement assumptions for the NOA IC analysis: this provides greater consistency between the NOA and NOA IC analysis which we believe is of added value to our stakeholders.
- 3.15 We intend to use essentially the same iterative method used last year. The studies will involve a step-by-step process, where the market is modelled with a base level of interconnection, including current interconnection levels and projects with regulatory certainty. Four separate solutions will be created and hence a range for the optimal level of interconnection, as in NOA IC 2019/20, which stakeholders felt was more realistic and useful.
- 3.16 We will continue to calculate Social Economic Welfare (SEW) based on SEW for GB and the connecting country only. This makes the direct welfare benefits of the interconnector more transparent and avoids any SEW generated by flows between other countries.
- 3.17 We will continue to highlight the impact of interconnection on carbon costs and renewable energy curtailment.
- 3.18 We will provide a similar level of detail to that provided in NOA IC 2019/20, but will continue to focus on providing greater insight and explanation into what is driving the results and also improve the graphical representation of results.
- 3.19 We will continue to develop NOA IC based on stakeholder recommendations.

### Factors for the assessment of future interconnection

- 3.20 There are multiple factors which could be considered when evaluating interconnector projects. The foremost are social economic welfare, capital costs and impact on constraint

- costs. Constraint costs refer to GB network congestion costs borne by GB consumers as a result of interconnection.
- 3.21 SEW, CAPEX and Attributable Constraint Costs (ACC) are the most significant criteria for identifying the optimal level of interconnection. Therefore, these factors will be used in the analysis to determine the economically optimal level of interconnection.
- 3.22 Two further factors that will be analysed and have some accompanying commentary in the NOA report are changes in carbon emissions and use of Renewable Energy Sources (RES). These indicators are intended to aid understanding of interconnection's potential impact to meeting GB's climate change goals. They will not be used to optimise the interconnection presented. This is due to the complexity of combining Carbon/RES estimates with welfare and cost, especially where modelled welfare is already influenced by such factors through RES incentives and the European Trading System capping carbon emissions.
- 3.23 **Carbon costs:** modelling facilities allow for the extraction of total carbon emissions resulting from particular market states under different scenarios, thus the carbon savings or increases associated with various levels of interconnection can be presented with commentary.
- 3.24 **RES integration:** modelling facilities allow for the investigation of the impact of interconnection on renewable generation. This can be reviewed through investigating the reduction or increase in renewable generation curtailment driven by the optimal level of interconnection being in place in future years, rather than the currently forecast level.

### Factors outside the methodology scope

- 3.25 There are further benefits and costs that could be considered, which are briefly outlined below; they are outside the scope of this methodology:
- 3.26 **Operational costs:** Various costs associated with the day-to-day operation of the interconnector, and the maintenance of its components, are omitted from the analysis. This is driven by the complexity of defining these costs, per market. There is a high correlation between capital spend (which is included) and these operational costs. Moreover, there is unlikely to be a substantial variation in the 'standard' operational costs per European market under consideration, meaning it is equitable to remove them from consideration for all markets
- 3.27 **Environmental/social costs:** In any large scale construction project, the local environment may potentially suffer damage. This affects local stakeholders, as well as disruption associated with the construction (traffic, noise etc.). The severity varies with the site chosen and the construction methods used. These are not considered here as they are more relevant to the choice of sites for individual projects.
- 3.28 **Social benefits:** Depending upon the procurement for the construction, the project may offer a boom to the local economy. This again is a project specific benefit, so is not estimated in this work.
- 3.29 **Ancillary Service costs:** We will not attempt to model the potential impact of interconnectors on services which support system operability. An analysis of system operability as part of NOA for Interconnectors does not fit well with the high-level market signal approach of other NOA for Interconnectors work. These costs will continue to be explored as part of the System Operability Framework which takes a holistic view of the changing energy landscape to assess the future operation of Britain's electricity networks.

### Cost estimation for interconnection capacity

- 3.30 The cost of building interconnection capacity varies significantly between different projects - key drivers are converter technology, cable length and capacity of cable. Estimating costs for generic interconnectors between European markets and GB is therefore challenging. An exercise of a similar nature has been undertaken by various industry bodies to allow the generation of 'Standard Costs'. These are generic values that can be applied to estimate the

cost of generic projects. A report by ACER<sup>11</sup> provides sufficient granularity to differentiate between standard costs of connection to different markets. There are three elements to the capital costs; subsea cable, onshore connection costs and wider reinforcement costs. We will continue to review and investigate alternative robust sources for generic interconnector cost estimates.

- 3.31 Subsea cable costs will be identified by estimating the furthest and shortest realistic subsea cable length and taking the average distance for each market to GB zone permutation. Suitable substations have been identified using the ENTESO-E Transmission System Map. The length of the cable will vary with the GB zone it is connecting to and the measurements will be taken between these to the nearest 5km and are shown in the following table.

Table 3. 1 Route distances

Country	GB Zone	Distance (Km)
Norway	1	705
Norway	2	795
France	5	175
France	6	100
Netherlands	4	215
Netherlands	6	210
Denmark	4	620
Denmark	7	660
Ireland	2	220
Ireland	3	220
Germany	4	520
Germany	7	590
Belgium	4	185
Belgium	6	140

- 3.32 Onshore connection costs will be excluded as the interconnector study cases are zone specific but not substation specific.
- 3.33 Wider reinforcement costs will be included in capital costs for options where applicable.
- 3.34 The convertor station assumed value is drawn from an averaging of known HVDC projects performed by ACER. The ACER cost estimates are shown in the table below (these costs include the cost of installation):

<sup>11</sup> [http://www.acer.europa.eu/Official\\_documents/Acts\\_of\\_the\\_Agency/Publication/UIC%20Report%20-%20Electricity%20infrastructure.pdf](http://www.acer.europa.eu/Official_documents/Acts_of_the_Agency/Publication/UIC%20Report%20-%20Electricity%20infrastructure.pdf)

Table 3. 2 Standard costs

Total cost per route length (km)	Rating	Mean (€, 2014)
DC cables <sup>12</sup>	250-500kV	757,621
OHL <sup>13</sup>	380-400kV (2 circuits)	1,060,919
Underground cables <sup>21</sup>	380-400kV (2 circuits)	4,905,681

Total cost per rating (MVA)	Mean (€, 2014)
HVDC convertor station	87,173

3.35 At the start of the analysis, the suitable rate of conversion from 2014 euros to present day sterling will be drawn from a credible source available to the ESO. The table can then be used to generate a generic cost for a given increase in capacity for each market. As connection can occur across a range of years, discounting is employed to standardise each cost in Present Value. This is done with the Social Time Preference Rate (STPR) of 3.5%. Additionally, the cost of capital is taken account of through the use of a Weighted Average Cost of Capital (WACC) of 6.8% for interconnectors, drawn from a publicly available Grant Thornton report.<sup>14</sup>

## Cost estimation for network reinforcements

- 3.36 The network will be divided into a number of high level zones. The zones will be determined by areas of significant constraints on the network, based on NOA 2020/21 results, and areas of high interconnection.
- 3.37 The baseline boundary capabilities will be determined by using the outputs from the main NOA 2020/21 analysis. Additional boundaries, and hence zones may be added if their addition may increase the value of the analysis.
- 3.38 Generic reinforcements will be created for each boundary, where necessary. These will be based on where there are high levels of congestion on the network and provide an indication of the level of reinforcements required.

## Components of welfare benefits of Interconnectors

### Introduction

3.39 This section outlines the definition of Social Economic Welfare. The purpose of this section is to give the theoretical background of assessing the impact of connected importing and exporting markets on consumers, producers and interconnectors triggered by another interconnector.

### Social and Economic Welfare

3.40 Social and Economic Welfare (SEW) is a common indicator used in cost-benefit analysis of projects of public interest. It captures the overall benefit, in monetary terms, to society from a

<sup>12</sup> The DC cable cost provided is for a 500MW cable. An assumption has been made that for a 1000MW interconnector the cost per km will be double.

<sup>13</sup> The rating on the figures above is sufficient to accommodate an additional 2000MW of interconnection. Therefore, the figures will be adjusted to incur 70% of the total cost for the first 1000MW of capacity required and 30% for the second 1000MW of reinforcement capacity on the same boundary.

<sup>14</sup> <https://www.ofgem.gov.uk/ofgem-publications/51476/grant-thornton-interest-during-construction-offshore-transmission-assets.pdf>



given course of action. It is important to understand it is an aggregate of different parties' benefits - so some groups within society may lose money as a result of the option taken. The society considered may be a single nation, GB, or the wider European society, in which case the benefits to European consumers and producers would be a part of the calculation. For the case of GB interconnectors, it is most informative to show both GB and the connected market's SEW values, and the components which make up each.

- 3.41 SEW benefits of an interconnector includes the following three components:
  - a) Consumer surplus, derived as an impact of market prices seen by the electricity consumers
  - b) Producer surplus, derived as the impact of market prices seen by the electricity producers
  - c) Interconnector revenue or congestion rents, derived as the impact on revenues of interconnectors between different markets.
- 3.42 Interconnectors could help to provide ancillary services (including black start capability, frequency response or reserve response), facilitate deployment of renewables, reduction in carbon emissions and displace network reinforcements. Interconnectors also provide benefits of being connected to more networks giving access to a more diverse range of generation which could lead to reduction in carbon emissions. Such benefits will not be a part of the main NOA IC assessment, as discussed in the previous section.

### Effects on Interconnected markets

- 3.43 Power flow between two connected markets is driven by price differentials. Figure 3.1 shows the effects of such price differentials for two markets, A and B with variable prices over time. When the price is higher in market A, power will be transferred from B to A. When the price in A is lower than B power will be transferred from A to B.

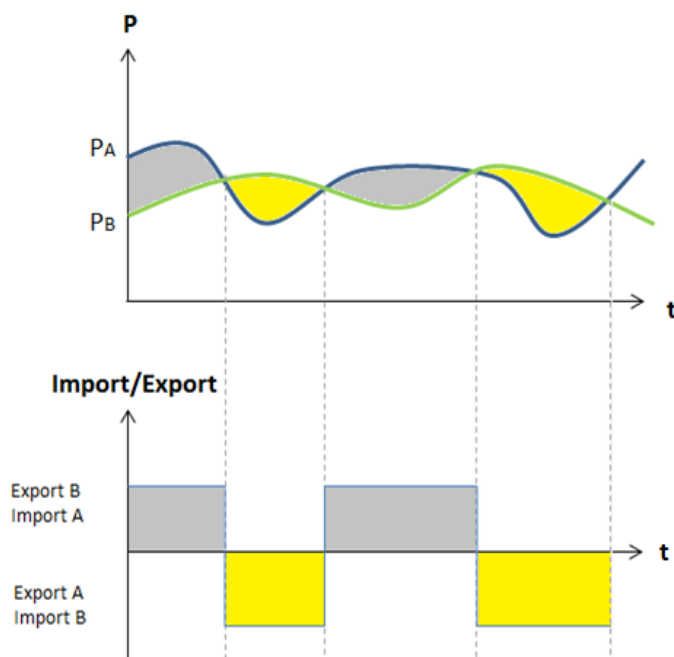

Figure 3. 1 Price difference as import and export driver

- 3.44 Figure 3.2 shows the impact of an interconnector (+IC) linking two markets on consumer (Demand D) and producer (Supply S) costs. When two competitive markets with different price profiles are interconnected, price arbitrage drives power flow from the low price market (B) to the high price market (A). Consumers in market A are likely to gain (a + b) as they benefit from access to cheaper power. Consumers in market B are likely to lose (d). Generators in market A must now also compete with generators in B and are likely to be forced by competitive pressures to reduce their costs. This may lead to a reduction in their

profits (a). Producers in market B are likely to gain (d + e). Interconnector revenue (c) is derived from the remaining price difference.

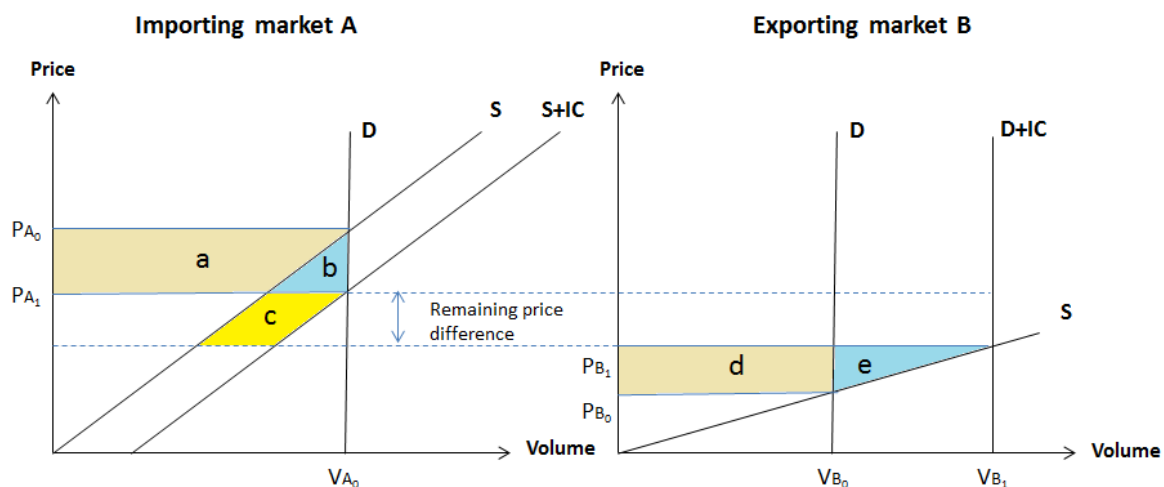

Figure 3.2 Consumer and Producer Surplus of connected markets

- 3.45 With greater interconnection, the price difference between markets will decrease thus the revenue of the interconnector will be reduced as well. This phenomenon is known as ‘cannibalisation’. There is an optimal level of interconnection between any two markets because price differential reduces as capacity increases, i.e. area c in Figure 3.2 shrinks.
- 3.46 Forecasts of all components of SEW benefits will be key drivers to ascertain the optimum level of interconnection between GB and other European states. The outputs of this process will include monetised impacts on consumers, producers and considered interconnectors.
- 3.47 The Global SEW is the sum of the welfare of 5 parties (GB consumers, Europe consumers, GB producers, Europe producers and Interconnector owners). The British SEW is the sum of the welfare of all British parties. Using the ownership structure of existing GB interconnectors, assuming 50% of interconnector owner welfare remains in the GB economy is plausible.
- 3.48 Where the market is modelled with and without some additional interconnection capacity added, SEW is modelled in each year of a generic asset’s lifetime (25 years is the standard assumption used here). As connection can occur across a range of years, discounting is employed to standardise each year’s benefit in Present Value, also allowing comparison with the discounted capital spend. This is done with the Social Time Preference Rate of 3.5%.

### Constraint cost implications of interconnection

- 3.49 The impact on constraint costs is dependent on the location of the interconnector on the GB network and the level of onshore reinforcement built to accommodate the interconnector. Further detail regarding optimal locations to connect will be output based upon the constraint costs calculated on the network with the interconnectors under consideration.
- 3.50 Constraint costs are incurred on the network when power that is economically “in merit” is limited from outputting due to network restrictions. In this event, the ESO will incur balancing mechanism costs to turn down the generation which is not able to output and offer on generation elsewhere on the system to alleviate the constraint.
- 3.51 The output of the ETYS and NOA reports provides information on the current state and ongoing developments of the onshore network. This will be used to provide a general picture of the optimal network areas for accommodating interconnectors from certain countries. This will be based on constraint costs attributable to the interconnector under review. ETYS and NOA quantify the boundary limitations and present recommended options for reinforcement of the grid. This is intrinsically linked to the increasing presence of interconnection in the UK which can cause further strain on boundaries and potentially trigger investment in further reinforcements if the NOA process determines that to be the most economic and efficient course of action.

## BID3 model

- 3.52 BID3 is the tool which will be used to perform the NOA IC 2020/21 and employed by the ESO to carry out a range of economic analysis.
- 3.53 BID3 is a Pan European Market Model created by Pöry Management Consultants. BID3 will be used by National Grid to forecast the Socio-Economic Welfare (SEW) and the Attributable Constraint Costs (ACC).
- 3.54 A comprehensive guide to how National Grid uses BID3 for calculating constraints is available on our website<sup>15</sup>. It is an economic dispatch model which can simulate all ENTESO-E power markets simultaneously from the bottom up i.e. it can model individual power stations for example. It includes demand, supply and infrastructure and balances supply and demand on an hourly basis. BID3 models the hourly generation of power stations on the system, taking into account fuel prices, historical weather patterns, socio-economic welfare and operational constraints.
- 3.55 The GB electricity system in BID3 is represented by a series of zones that are separated by boundaries. Generators are allocated to their relevant zone based on where they are located on the network, and then the appropriate demand is allocated to that zone. The boundaries, which represent the actual transmission circuits facilitating the zonal connectivity, have a maximum capability that restricts the amount of power which can be securely transferred to across them.
- 3.56 The socio-economic welfare is calculated by summing the producer surplus, consumer surplus and interconnector revenue. The consumer surplus is the difference between the value of lost load and the wholesale price. The producer surplus is calculated and summed per plant based upon their Short Run Marginal Cost and the wholesale price.

## Options included in the assessment

- 3.57 As there are infinite combinations of markets and reinforcements, applying engineering judgement, the number of options has been reduced to 29 credible study cases. These 29 study cases will be assessed in all iterations across all four scenarios.
- 3.58 The options which will be assessed are included in Table 3. 3 below. The boundary reinforcements and zones refer to Figure 3.1.

Table 3. 3 Options to be considered in the analysis

Market and Zone	Boundary Reinforcements	Market and Zone	Boundary Reinforcements
<b>Belgium Zone 4</b>	c	<b>Ireland Zone 2</b>	b
<b>Belgium Zone 4</b>	None	<b>Ireland Zone 2</b>	None
<b>Belgium Zone 6</b>	None	<b>Ireland Zone 3</b>	None
<b>Belgium Zone 6</b>	d + e	<b>Netherlands Zone 4</b>	c
<b>Denmark Zone 4</b>	c	<b>Netherlands Zone 4</b>	None
<b>Denmark Zone 4</b>	None	<b>Netherlands Zone 6</b>	None
<b>Denmark Zone 7</b>	None	<b>Netherlands Zone 6</b>	d + e
<b>France Zone 5</b>	None	<b>Norway Zone 1</b>	a + b

<sup>15</sup> <https://www.nationalgrid.com/sites/default/files/documents/Long-term%20Market%20and%20Network%20Constraint%20Modelling.pdf>

France Zone 5	d	Norway Zone 1	None
France Zone 6	None	Norway Zone 2	b
France Zone 6	d + e	Norway Zone 2	None
France Zone 6	d		
Germany Zone 4	c		
Germany Zone 4	None		
Germany Zone 4	f		
Germany Zone 7	None		

## Interconnection Assessment Methodology

### Optimisation of GB-Europe Interconnection Process

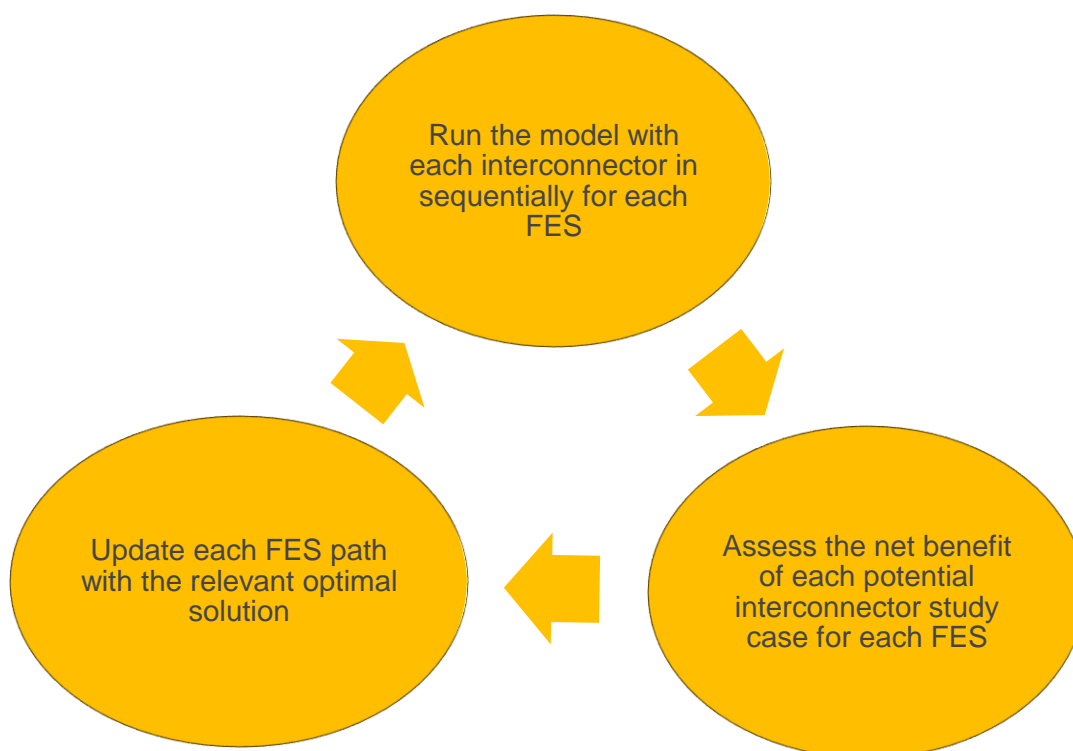

Figure 3. 1 Process summary

3.59 The optimisation of future interconnection capacities is a multivariable search, maximising the SEW less CAPEX less Attributable Constraint Costs (ACC) value. The decision variables are the total MW capacities (the sum of all interconnector transfer capacities) between GB and 8 adjacent markets, for both importing and exporting. These markets are national electricity markets- there is some level of coupling between many of them, however price areas (areas with the same electricity price throughout) generally align with nations. Where some nations have multiple price areas, such as Norway, interconnector projects will be assumed to be in the coastal price area deemed most likely for interconnection to the UK. The countries in question are: Norway; Denmark; Germany; The Netherlands; Belgium; France; and Ireland (which includes the Republic of Ireland and Northern Ireland). For each country's additional



interconnector capacity, there will be a small number of zones and reinforcement combinations studied. The number of variables makes an exhaustive search within a useful timeframe infeasible - a search strategy must therefore be defined.

- 3.60 Due to the unique properties of the Icelandic market, any interconnection to Iceland which appears in the Future Energy Scenarios (FES) will remain in the background. Further Icelandic interconnection will be removed from the iterative process.
- 3.61 The search is just for interconnection to GB. The level of interconnection between European markets will remain fixed throughout the scenarios (though could vary across future years). These levels are defined by the FES European scenarios.
- 3.62 The market studies, which model the physical limitations of transmission between markets (but not within markets) start from the baseline level interconnection. The interconnection capacities are then adjusted sequentially to search for improvements on this initial point, represented by an increase in the total SEW - CAPEX - ACC following the alteration of the capacity values. This total SEW-CAPEX-ACC value takes into account the whole asset life, such that the overall timing of connection is assessed in addition to the capacities per market.

### Modelling inputs

- 3.63 The starting point of the process is National Grid's FES 2020 which includes generation plant ranking orders and demand forecasts across Europe for each scenario. Output from NOA 2020/21 will be used to determine the high level boundary capacities which form the zones included in the analysis. All interconnectors which are in the NOA IC baseline will be included in the model from 2028 (the first year of study).
- 3.64 The FES make forecasts of the future interconnection capacities in GB, per scenario. The FES level of interconnection is calculated on a project by project basis, reviewing all axioms from economic, political, environmental etc. An important distinction between the FES and this process, therefore, is that the NOA IC aims to find what would be economically optimal rather than being based on specific projects. A shortfall of interconnection baseline capacity relative to FES level of interconnection will then drive further interconnection in the results.
- 3.65 A key assumption with NOA IC is the baseline level of interconnection. This is the level of interconnection to commence the analysis from. For NOA IC 2018/19 and previous cycles, we had included projects within the interconnector baseline against the criteria of "regulatory certainty". We received feedback that using this criterion was inappropriate for several reasons, including that it excluded certain projects with project of common interest (PCI) status and that the criteria of regulatory certainty was open to various interpretations. We also received feedback that a more appropriate methodology would be to include a broader criterion for inclusion of interconnectors and to apply an appropriate scaling factor to ensure the baseline level of interconnection facilitates a credible analysis.
- 3.66 For the baseline level of interconnection within NOA IC 2019/20 we used, as a starting point, all interconnector projects currently operational, those under construction and those included on the NGENSO Interconnector Register. The interconnector register lists all GB interconnector projects that have currently signed a connection agreement to connect to the GB electricity transmission system. The interconnector register is a public domain document that is updated throughout the year. Nearly all interconnector projects to GB that have PCI status are included within the interconnector register. If we add up the capacity of all existing operational GB interconnectors, those currently under construction and those listed on the interconnector register, this results in a figure of 21 GW: to achieve a credible baseline figure, a scaling factor of 25 per cent was applied to projects under development (but not under construction). This results in a baseline interconnection level of 13.6 GW. Note that the 25 per cent scaling factor should not be interpreted as specific projects having a 1 in 4 probability of completion: the scaling factor represents the scaling necessary to achieve a reasonable baseline level of interconnection to commence the analysis from.
- 3.67 It is important to note that the baseline level of interconnection capacity should not be viewed as NGENSO attempting to "pick winners and losers" in terms of which projects currently under development will become operational. The baseline is not an assessment of the likelihood of individual projects progressing: it represents a credible aggregation of projects currently under development that can be used as a starting point for the NOA IC analysis. Certain projects

- currently under development will not progress to completion and other new projects will appear.
- 3.68 We received feedback from several parties regarding the revised approach for setting the baseline level of interconnection for NOA IC 2019/20. One stakeholder stated that whilst the approach had its merit, it resulted in a baseline where only a fraction of a particular interconnector project is included within the baseline, which is unrealistic from a delivery point of view. We agree this is not ideal, but this approach avoids having to include specific “winning” projects within the baseline and excluding other “losing” projects. In addition, as the iterative approach includes both a 1GW and a 500MW step, the methodology allows for 500MW incremental interconnector blocks.
- 3.69 We also received feedback that a more appropriate method for selecting the baseline level of interconnection would be to analyse current projects under development by using metrics such as developer experience, regulatory approval, level of project development and supply chain factors. We agree that such an approach is very useful for assessing the relative progress of existing interconnector projects under development, but by definition this approach results in the baseline interconnector level being set by picking “winners and losers” based on existing interconnector projects, which we are keen to avoid.
- 3.70 NGESO proposes using the methodology used for NOA IC 2019/20 for setting the baseline level of interconnection capacity for the NOA IC 6 2020/21 analysis. The methodology avoids any ambiguity around the definition of regulatory certainty, and starts from a position of considering all projects within the Interconnector Register, which gives a broader reflection of the scope of projects currently under development.
- 3.71 We will continue to review the approach for setting the baseline level of interconnection before commencing the NOA for Interconnectors 2020/21 work and we welcome any additional comments and suggestions for improvement to setting the baseline interconnector level from our stakeholders.
- 3.72 The time period considered in the studies extends from the present to 2040. This is to match the FES, which will forecast up to 2040 in detail. For the timing analysis, only capacity in years 2028, 2030 and 2033 will be investigated. The reason for not starting to analyse additional capacity until 2028 is this is deemed the earliest an entirely new interconnector project could realistically be connected. Studying every year thereafter is infeasible, as each additional year studied requires a further set of model runs in the optimisation. This would lead to an unachievable number of required market simulations as constrained by time limitations.

## Market modelling

- 3.73 The selected method of arriving at a recommendation for capacity development is an iterative optimisation per scenario. The iterative optimisation approach attempts to maximise present value, equal to SEW less CAPEX less Attributable Constraint Costs (ACC), using a search strategy. The whole process is repeated four times to arrive at an optimal development of capacity in each of the four FES. This year, like last year, based on strong stakeholder feedback, there will be no Least Worst Regret calculation at the end of each iterative step, resulting in four optimal paths: one per FES and hence a range for the optimal solution will be produced. A balance between computing resource and rigour in each step of the process must be found. An example step is outlined below, wherein multiple capacity changes are evaluated for SEW in each step.
- 3.74 Timing of capacity increases can affect the SEW generated and Attributable Constraint Costs (ACC) by the interconnection across the study window. Within each search step, therefore, timing combinations will be considered. The use of spot years will be necessary to allow a solution to converge, wherein the commissioning of additional projects would be evaluated only in future years 2028, 2030 and 2033. This means for each iteration, the welfare of the interconnectors in every spot year will be calculated.
- 3.75 The example below is based on a hypothetical situation, optimising the capacities and optimal timing of connection for potential interconnection to 4 markets. It shows a sample of the options of market, connecting year, FES scenarios, GB zone and reinforcement that need to be considered for each iterative step.

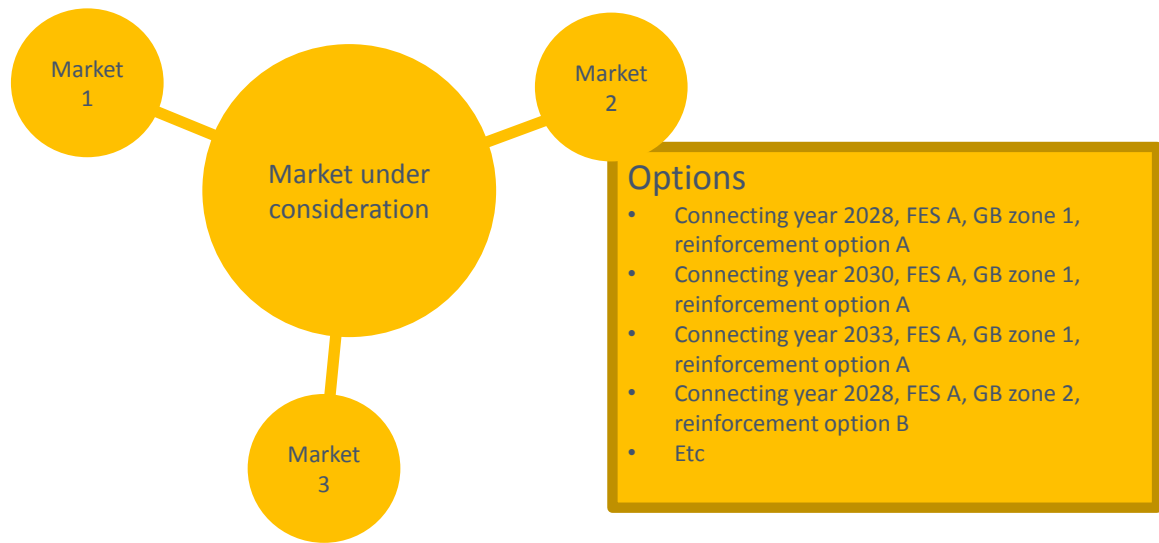

Figure 3. 2 Example Markets

Table 3. 4 Example of iteration 1 search step

	Iteration 1 Transfer Capacities (MW)						
	Baseline	Study case 1		Study case 2		Study case 3	
		Increment	Simulated capacity	Increment	Simulated capacity	Increment	Simulated capacity
FES A Market 1	2000	+1000	3000	0	2000	0	2000
FES A Market 2	1000	0	1000	+1000	2000	0	1000
FES A Market 3	1000	0	1000	0	1000	+1000	2000
<b>FES A CHANGE IN SEW-CAPEX-ACC</b>	<b>0</b>	<b>+ £12M</b>		<b>+ £5M</b>		<b>+ £8M</b>	

3.76 Table 3. 4 gives an example of the iteration search step 1, whereby an additional 1000 MW of capacity is added sequentially to each option. The option that produces the highest change in SEW-CAPEX-ACC for each FES (in this example study case 1, with an additional 1000MW interconnector to market 1) is then added to the baseline for the iteration search step 2 for that particular FES, as shown in Table 3. 5.

Table 3. 5 Example of iteration 2 search step

	Iteration 2 Transfer Capacities (MW)						
	Baseline	Simulation 1		Simulation 2		Simulation 3	
		Increment	Simulated capacity	Increment	Simulated capacity	Increment	Simulated capacity
FES A Market 1	3000	+1000	4000	0	3000	0	3000
FES A Market 2	1000	0	1000	+1000	2000	0	1000
FES A Market 3	1000	0	1000	0	1000	+1000	2000
<b>CHANGE IN SEW – CAPEX-ACC</b>	<b>0</b>	<b>+ £7m</b>		<b>+ £5M</b>		<b>+ £5M</b>	

FES A Market 1 Increased by 1000MW following the result of iteration 1 for FES A

- 3.77 The search finishes when it is deemed to have converged - that is, no further capacity alterations yield a higher overall present value for the whole study window for each scenario. The optimal capacity profiles will then be presented in the NOA report, providing the industry with a range, that is one for each FES.
- 3.78 To improve efficiency of arriving at the end of the optimal path, the incremental steps will be of 1000MW of capacity. Once there is no additional benefit from any interconnectors, the incremental capacity will be reduced to 500MW to analyse whether there is any benefit of a further 500MW.

### Further Output

- 3.79 Accompanying the output of the optimal path market and network analysis, additional results will be provided illustrating the benefit each interconnector would potentially provide. This is to overcome this possibility of misinterpretation of the results, as many interconnectors which don't appear in the optimal path individually have a positive net benefit to consumers and therefore development should continue to be pursued.

### Process Output

- 3.80 The above methodology will be employed to create a chapter of the NOA 2020/21 report. This chapter will present the main findings of the analysis – a range for optimised interconnection capacity level by market, and the best timing for capacity increases across all scenarios. It will include commentary on these results.
- 3.81 The analysis aims to provide stakeholders with a quantified assessment of the potential benefits of additional interconnection to GB. The output from the 2020/21 NOA is used as input into the NOA IC analysis for setting the baseline network reinforcement assumptions. The output of NOA IC does not feed directly into the creation of the next set of FES. The FES level of interconnection is calculated on a project by project basis, whereas NOA IC aims to find what would be economically optimal rather than being based on specific projects. The results will be delivered by 31st January 2021.





# 4

**Suitability for third party delivery  
and tendering assessment**

## Overview

- 4.1 Following the statutory consultation on C27 changes held between 16 December 2019 and 20 January 2020, Ofgem announced its decision on 23 April 2020. The changes placed a clear role on the ESO to play in facilitating the introduction of competition. This role applies to NOA wider network reinforcement options that we recommend and also connections or modifications to existing connections that arise from applications. The ESO therefore assesses for competition major network reinforcements against these criteria of new, high value and separable. This methodology describes the process for the assessment for both wider network reinforcement and connections. It should be noted that, in the current NOA, the time for the competitive tendering process is not considered when the TOs submit the EISDs or delivery dates for their wider transmission reinforcements or enabling works<sup>16</sup> for connection projects.
- 4.2 The ESO assesses the suitability of projects for competition in accordance with published tendering criteria<sup>17</sup>. The single year regret analysis process identifies the recommended options. For each set of options, the ESO identifies the most relevant options and assesses these options against the tendering criteria, which are options that are:
- new,
  - separable,
  - high value.

In order to undertake the assessment, the TOs will provide information to the ESO via the SRF form (see appendix D) for wider works. The ESO then carries out the following process:

- Reviews the information provided for each option.
- Assesses the most relevant options against the criteria for competition.
- Provides a recommendation for the options on how they meet or do not meet the criteria for competition and hence the options' suitability for competition.

Note that some options will clearly not meet the criteria for competition, for instance because their value is far below the threshold. As a result, not all options are assessed for competition.

- 4.3 In addition to wider network reinforcement, the NOA also examines connections for eligibility for competition. For each NOA, the ESO assesses transmission connections against the same criteria as wider work options (described above) and publishes the conclusions in the NOA. The assessment against the criteria does not mean that investments meeting the criteria will be subject to competitive tendering. Any decision for competitive tendering lies with Ofgem.

## Connections

- 4.4 Prospective users can make connection applications and modification applications at any time of year whereas the NOA process works on an annual cycle. As a result the ESO assesses connection projects when it receives them. Few connection projects meet the value criteria of £100m and of those that do, many provide wider network benefits and hence are of interest and already included in the NOA process. The ESO uses the connection contract between the ESO and the prospective user to take a view of the likelihood of meeting the value criteria.
- 4.5 For a new connection, the ESO identifies the projects where there is the possibility of the required enabling works (not including works already covered in the NOA) meeting the value criteria. The ESO informs the relevant TO(s) of the projects and provides a summary of the work proposed and the costs. This is in time for the ESO to perform the assessment in October.

---

<sup>16</sup> For the definition of 'enabling works', please refer to section 13 of the Connection and Use of System Code (CUSC) <https://www.nationalgrid.com/sites/default/files/documents/Complete%20CUSC%20-%20%201%20April%202018.pdf>

<sup>17</sup> [https://www.ofgem.gov.uk/system/files/docs/2018/01/competition\\_update.pdf](https://www.ofgem.gov.uk/system/files/docs/2018/01/competition_update.pdf) and [https://www.ofgem.gov.uk/system/files/docs/2019/02/criteria\\_guidance.pdf](https://www.ofgem.gov.uk/system/files/docs/2019/02/criteria_guidance.pdf)

- 4.6 If the TO states that a project has wider network benefits, it can use the SRF at the usual time in the NOA process to submit the information for the competition assessment process.
- 4.7 The TO(s) responds to the ESO's summary of the projects and the ESO then uses the summary together with any input from the TO(s) for the process to assess eligibility for competition.

### Bundling/splitting of work packages

- 4.8 The first step in the ESO's competition assessment of larger projects, is to provide an opinion on bundling projects into larger packages, or splitting projects into smaller packages, to form a recommendation in the NOA. There are two aspects to the ESO's consideration of bundling and splitting as follows:
- a. The costs and size of the component aspects of projects to ensure that they can be most appropriately packaged.
  - b. Where the ESO can identify opportunities or benefits from repackaging of projects.

### Bundling

- 4.9 The ESO considers whether combining one or more projects into a single tender could be appropriate (if they have common needs/drivers or it makes technical or commercial sense) and whether it is in the interests of consumers (e.g. economies of scale for procuring large quantities). If the ESO believes that there is benefit from bundling (and where the constituent projects have not been challenged or corrected), then each constituent project should meet the high value threshold. Where work is bundled as part of this process, the component parts must each meet the competition criteria to be eligible.

### Splitting

- 4.10 The ESO is expected to recommend splitting a project into more than one tender package if it is in the interest of consumers (for example if a project constitutes new assets and refurbishment of existing assets these could be split so new assets could be competed). When it considers splitting a project, the ESO will consider the impact this could have on project delivery. Each resultant package should meet the high value threshold, if these are to be competed.

### Competition criteria

- 4.11 Ofgem has stated that there are significant benefits to consumers in introducing competition into the delivery of transmission projects that meet defined criteria. These criteria are:
- **New** – completely new transmission assets or complete replacement of transmission assets.
  - **Separable** – ownership between these assets and other (existing) assets can be clearly delineated.
  - **High value** – at or above £100m in value of the expected capital expenditure of the project.

Figure 4. 1 shows the process for assessing whether reinforcement projects meet competition criteria.

- 4.12 Note that there are two stages in the high value assessment (red outline) and two stages in the separability assessment (green outline).
- 4.13 Process stages - the names of the process stages below match those on the diagram. The numbered stages below correspond to the boxes on the left side of the diagram.

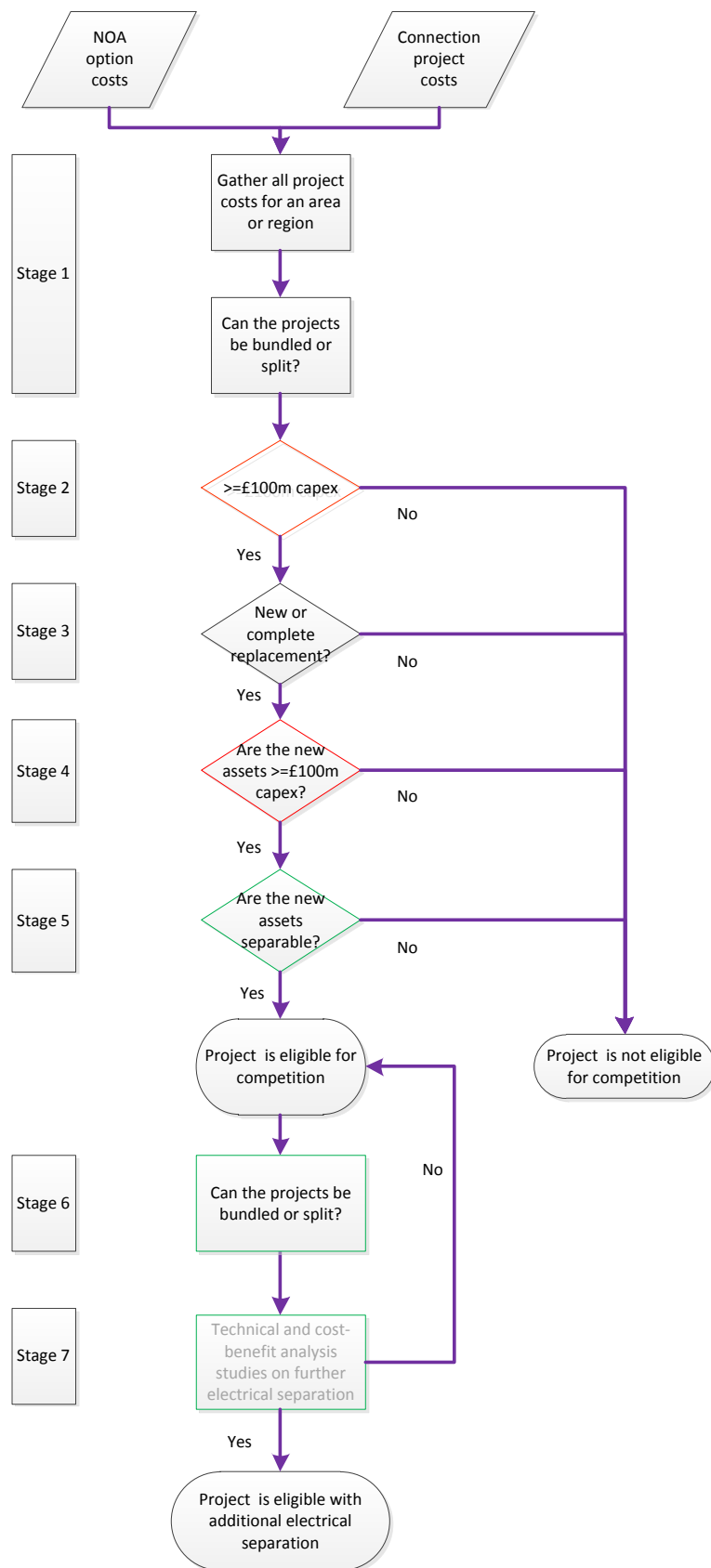

Figure 4. 1 The process for assessing suitability for competition



## Stage 1

### Can the projects be bundled or split?

Aim – to carry out a first check to ensure that sensible packages of work are developed together by assessing the proposed work to see if it should be split (broken into more than one smaller bundle) or whether work across more than one project should be bundled together.

Considerations when assessing potential for splitting:

- Does the project involve different technologies that suggests different skills and procurement are needed for the separate elements?
- Is there a variety of works involved? For example:
- Are there one or more new substations?
- Does the proposed project comprise OHL and cable sections and how do they affect existing networks?
- Are there one or more cable tunnels?
- Are the project phases adjoining or in naturally separate timeframes?
- Could the resulting work package lead to stranded investments?

Considerations when assessing the potential for bundling:

- Are there multiple projects with common needs / drivers?
- Are there several individual projects in a relatively self-contained area or corridor?
- Are there scheme works that are very similar?
- Is it one of several smaller projects that could be efficiently or more efficiently developed with other projects?

## Stage 2

### **>=£100m capex**

*Aim – to assess whether the project or bundle of projects meets the high value criteria and include only projects that exceed the threshold within a 10% margin for consideration at the next stage.*

Table 4. 1 lists the factors that affect the high value figure.<sup>18</sup>

Criteria – this is the first of a two-stage process (the second, stage 4 is below). The ESO uses the costs that the TO(s) have provided and that have undergone cost checking or that appear in the connection contract to calculate the cost (or where we are looking to create a bundled package the total costs) of the project. The ESO might seek advice from the TO if it has queries. The trigger threshold is set at £90m to highlight projects that are marginally below the £100m figure. This produces a straight yes/no output.

---

<sup>18</sup> As applied to the current framework for cost allocation under the RIIO-T1 framework



Table 4. 1 List of factors that the high value figure includes or excludes

The £100m capex 'high value' figure	
includes	excludes
<ul style="list-style-type: none"> <li>Costs of acquiring land</li> <li>Costs of complying with consents conditions</li> </ul>	<ul style="list-style-type: none"> <li>Costs of gaining consent</li> </ul>

### Stage 3

#### New or complete replacement

Aim – to test the projects against whether they are new assets or complete replacement assets rather than, say, refurbished assets. This test has the practical benefit of checking for complicated examples. For example, where a new double circuit crosses an existing double circuit and because of routing and the existing circuits, the existing circuits need modification leading to new assets integrated into existing circuits. Thus, the affected existing circuits would become a mix of old and new assets. The consenting process might also change a simple double circuit route into a complicated one that includes mixed ownership because of old and new assets being integrated. As the project, will be assessed annually in the NOA process this might lead to a change in the project's eligibility, from one year's assessment to another.

Criteria – is a project delivering completely new assets or complete replacement assets that fulfil the same function of the assets to be removed or replaced? This produces a straight yes/no output.

### Stage 4

#### Are the new assets $\geq$ £100m value?

Aim – to test whether the new assets reach or exceed the high value threshold.

Criteria – this is the second part of a two-stage process (the first, stage 2 is above). If the project has a very high proportion of new assets and high value, the project will pass this stage. For more marginal projects, the ESO uses the breakdown of costs from the TO to calculate the value of the new assets. This produces a straight yes/no output.

### Stage 5

#### Are the new assets separable?

Aim – to test whether the project details indicate that the new assets are readily separable from the existing assets.

Criteria – this is to check if the project already has points of connection to existing assets that can be clearly delineated, in other words, clearly identified. Disconnectors are obvious points that can be delineated but Ofgem suggest that other points such as clamps on busbars would also be acceptable as long as the point can be clearly identified. This produces a straight yes/no output.

## Stage 6

### **Can the projects be bundled or split?**

Aim – having gone through the process to check for eligibility, this stage is a recheck that sensible packages of work are developed together.

Criteria – these are the same as for stage 1 (above). Note that projects that are split must have component parts that meet or exceed the £100m value threshold.

## Stage 7

### **Based on technical and cost-benefit analysis studies, is it appropriate for the ESO to recommend additional electrical separation for the projects that have met the competition criteria?**

If the ESO concludes that the project proposals already have adequate electrical separation, it is not necessary to carry out this stage.

Aim – use cost-benefit analysis studies to test technical solutions and determine if it is worth extra investment in assets or amending the design to further delineate ownership boundaries to provide adequate electrical separability.

The ESO is considering ways of conducting this assessment with the most likely being a study against some criteria to provide consistency. The ESO believes that the assessment will be needed by exception only.

The ESO maintains a log of connection projects that meet the competition criteria and liaises with the TOs about the outcomes of the competition eligibility assessments. This log forms the basis of the list that is published in the NOA.



# 5

## ESO process for Offshore Wider Works

## Foreword

- 5.1 This section contains National Grid ESO's proposed processes for Offshore Wider System Works in the following two areas:
- 5.2 **Offshore Wider Works – Developer Associated** describes the process for investment in transmission capacity to provide wider network benefit, which is led by developers (whether generator builds or OFTO build). It includes investment in offshore transmission assets or capacity that goes beyond that needed by a single developer and is for the purpose of supporting the reinforcement of the GB transmission network (the wider network). This could include investment providing for, or creating the potential for, increased boundary transfers between different zones of the wider network via offshore links.
- 5.3 **Offshore Wider Works – Non Developer Associated** describes the process for investment that would support reinforcement of the wider transmission network, but where developers are unwilling or unable to take forward the offshore wider works. Offshore Wider Works Non Developer associated Needs Case is in many cases a substitute for onshore wider works.

## Offshore Wider Works – Developer Associated overview

- 5.4 Current offshore transmission assets have been developed as standalone connections to shore known as radial connections. However, the Round 3 offshore wind projects are larger, more complex and at a greater distance from shore than those that have been developed so far. As a result there is likely to be the potential for efficiencies from greater coordination of offshore transmission infrastructure. This could include coordination between connections, and coordination of the strategic development of the wider network through offshore reinforcement projects.
- 5.5 Developer Associated Offshore Wider Works is investment in transmission capacity to provide wider network benefit, which is led by developers (whether generator builds or OFTO builds). It includes investment in offshore transmission assets or capacity that goes beyond that needed by a single developer and is for the purpose of supporting the reinforcement of the GB transmission network (the wider network). This could include investment providing for, or creating the potential for, increased boundary transfers between different zones of the wider network via offshore links.
- 5.6 The offshore connection offer process has a key role in the development of a coordinated offshore transmission network. Where it is economic and efficient, Offshore Wider Works may form part of a developer's connection offer and subsequent bilateral connection agreement (BCA)<sup>19</sup>.
- 5.7 In the December 2013 consultation, Ofgem proposed high level roles and responsibilities to support a gateway assessment process for Offshore Wider Works. In responding to the Ofgem proposals, stakeholders broadly agreed that the ESO should support the Needs Case for Developer Associated Offshore Wider Works at the gateway assessments. Ofgem maintains the position that the developer should lead in triggering and making submissions to the voluntary gateway assessments, and that the ESO (drawing on relevant Transmission Owners (TOs) as necessary) should assist with developing the Needs Case for the Offshore Wider Works for any Ofgem gateway assessments. Further, both parties will have a role in monitoring the Needs Case for the Offshore Wider Works, with the developer reviewing their design where this is an appropriate response to a change in the Needs Case.
- 5.8 Ofgem at this stage, consider that offshore developers should retain the choice to undertake preliminary Offshore Wider Works for the development of coordinated offshore transmission assets under a Developer Associated Needs Case.

---

<sup>19</sup> In planning and developing offshore transmission assets under the generator build option, developers are required under the Grid Code (Planning Code) to take into account reasonable requests from the NETSO where it is reasonable and practicable to do so (PC.8.3)



## Offshore Wider Works – Developer Associated: the ESO's role

- 5.9 Based on the consultation document from December 2013 a majority of the respondents agreed that the ESO should support the Needs Case for Developer Associated Offshore Wider Works. It was also very clear from the consultation that affected TO and offshore developer's contribution and cooperation would be also required. The following text is explaining each point of the ESO process for Developer Associated Offshore Wider Works.
- 5.10 Step 1: Identification of System Need. The Offshore Wider Works can be identified in two ways:
- a. The ESO assess the system need through the annual Electricity Ten Year Statement (ETYS) process. Some of the system reinforcement options will be Offshore Wider Works options and will be subsequently included in the NOA document.
  - b. Offshore Wind Farms Connection offers will also identify the investment need for the Offshore Wider Works.
- 5.11 Step 2: Offshore Wind Farm Connection Application and CION
- a. As part of the connection offer process, the ESO is required to provide details to the developer of the preliminary identification and consideration of the connection options available. This includes the preliminary costs used in assessing such options and the offshore works assumptions, including the assumed interface point identified. The ESO fulfils these requirements by the production of the Connections Infrastructure Options Note (CION). The CION sets out the offshore works assumptions and consideration of options available and is provided to the developer during the connection offer process.
- 5.12 Step 3 & Step 4: The ESO and offshore developer are working together on development of the Offshore Wider Works Options
- a. In collaboration with the offshore developer, the ESO develops the Offshore Wider Works options.
  - b. In developing Offshore Wider Works, the ESO will take into consideration two major transmission system design criteria: network capacity availability of the local boundary and shortfall of the wider system boundaries.
  - c. According to Chapter 2 of the NETS SQSS – Generation Connection design, the transmission system is designed to accommodate 100% of the transmission entry capacity at the connection point within a local boundary (e.g. for a 1GW wind farm connection, the onshore system is designed to accommodate the complete 1GW generation and the offshore assets are sized to provide this full transmission entry capacity.)
  - d. In planning the Main Interconnected Transmission System (MITS) however, different scaling factors are applied to different types of generating. In the case of wind, this implies that the assets are not assumed to be 100% utilised by the wind generated. Taking into account all these scaling factors, the offshore infrastructure is allowing some spare capacity in the assets. It is this 'spare' capacity that provides the opportunity for offshore wider works to be utilised as one of the options to provide boundary capability. In providing the Offshore Wider Works design it is crucial the ESO and offshore developer work together and agree on the generation background, scenarios and sensitivities which will be used as a basis for the Offshore Wider Works Design. In this stage the ESO will inform Ofgem on the agreed background and scenario between ESO and offshore developer.
  - e. The benefits of the Offshore Wider Works will also be assessed by utilising a combination of operational actions to maximise the capability across the boundaries (e.g. actions included QB optimisation and redirection of flows in HVDC links).
  - f. Once the ESO and the offshore developer agree on Offshore Wider Works options, the agreed Offshore Wider Works options are progressed into the cost-benefit analysis.
- 5.13 Step 5: Cost-benefit analysis. The ESO, supported with information from the offshore developer, perform the cost-benefit analysis on the agreed Offshore Wider Works options from Step 3 & 4. The rationale behind the Cost-benefit analysis is explained in the following text:

- g. The key economic objectives for cost-benefit analysis for Offshore Wider Works are:
    - vi. Ensure value for money for the consumers by delivering cost effective reinforcements to ensure economically efficient design and operation of the network.
    - vii. Timely delivery of necessary reinforcement(s) to minimise any cost exposure for consumers to either early investment or delayed implementation.
  - h. The objectives for Offshore Wider Works cost-benefit analysis are:
    - i. To be consistent with Licence obligations and National Electricity Transmission System (NETS) Security and Quality of Supply Standards (SQSS); the analysis promotes economic and efficient investment.
    - ii. To present economic justification for the preferred Offshore Wider Works designs and an explanation of how they compare with the alternative counterfactual case.
    - iii. To present evidence on expected long-term value for money for consumers considering a range of sensitivities
    - iv. To present evidence on optimal timing of the preferred reinforcement option.
  - i. Driven by these objectives the scope of the cost-benefit analysis is:
    - i. To establish the reference case position in terms of constraint costs forecasts associated with the 'do minimum' network state, across different generation background scenarios.
    - ii. To model the economic impact, measured as constraint cost savings, for a range of designs, across a range of scenarios.
  - j. To undertake a cost-benefit analysis by:
    - i. Appraising the economic case of the options by adopting the Spackman<sup>20</sup> approach and determining respective Net Present Values (NPVs) across the studied generation scenarios and sensitivities.
    - ii. Establishing worst regrets associated with each design/technology appraised.
    - iii. Identifying the Least Worst Regret option overall
    - iv. Assessing the impact of key sensitivities: increase in capital expenditure, and delays in delivery timeframes.
    - v. Make recommendations for the preferred option i.e. the Least Worst Regret solution, taking into consideration the impact of sensitivities.
- 5.14 Step 6: The ESO discusses the preferred Offshore Wider Works option from cost-benefit analysis (Step 5) with the offshore developer and affected TO
- 5.15 Step 7: Offshore Wider Works Needs Case submission through the voluntary gateway process
- a. The ESO makes a recommendation on preferred option for Developer Associated Offshore Wider Works. The ESO supports the offshore developer in its submission of the Offshore Wider Works Needs Case to Ofgem via voluntary gateway process
  - b. Based on the last consultation in December 2013 offshore developers will have the option to go through one or two Ofgem gateway assessments, timed broadly ahead of the commencement of preliminary works and ahead of construction works. Where a developer is comfortable that it can support its decision to develop the Offshore Wider Works as part of a cost assessment during a tender exercise, the developer can choose not to go through one, or both, of the gateway assessments. In general, Ofgem is expecting that two voluntary gateway assessments would be sufficient. However, if a developer considers that there are substantial benefits to passing through more than two gateway assessments in a particular case (for example in the case of particularly large,

---

<sup>20</sup> The Joint Regulators Group on behalf of UK's economic and competition regulators recommend a discounting approach that discounts all costs (including financing costs as calculated based on a Weighted Average Cost of Capital or WACC) and benefits at the Social Time Preference Rate (STPR). This is known as the Spackman approach. Further details of our assumptions regarding WACC and STPR are presented later in this document.

complex projects) Ofgem would look to engage with the developer to understand these benefits and consider the best way forward.

- c. At the first gateway assessment, Ofgem will review the rationale for including the Offshore Wider Works in a developer's design solution at the preliminary works stage. This is the case for developers following both the generator build and OFTO build option. Where Ofgem is convinced by the developer's rationale for undertaking certain preliminary works associated with the Offshore Wider Works, Ofgem would not reassess this rationale during the tender exercise.
- d. At the second gateway Ofgem will review the rationale for constructing the Offshore Wider Works. Where the developer chooses the generator build option, the Ofgem assessment at the second gateway will inform the cost assessment process undertaken during the subsequent tender exercise. Where Ofgem is convinced by the developer's rationale for including specific additional, or oversized, transmission assets associated with the Offshore Wider Works, Ofgem would commit to not reassessing this rationale during the tender exercise. Where a developer is following the OFTO build option, the Ofgem assessment will help to inform the scope of the OFTO build tender exercise.
- e. Any Ofgem commitment regarding not re-assessing the rationale for the Offshore Wider Works at the first or second gateway, would be conditional on the ESO and the offshore developer continuing to engage and monitor the Needs Case for the Offshore Wider Works. Where the Needs Case changes, Ofgem expects these parties to review the design of the offshore assets and make any necessary changes where this would be economic and efficient. Ofgem is expecting that this process would take into account both the needs of the wider network and the impact of any changes on the cost and timing of an offshore developer's connection. In some instances, a change in the Needs Case for the Offshore Wider Works may mean that the Offshore Wider Works is no longer taken forward.
- f. All the costs incurred in connection with development and construction of the agreed scope of the transmission assets, including the Offshore Wider Works elements, would remain subject to the economic and efficient test as part of Ofgem's cost assessment.

#### 5.16 Step 8: Voluntary Gateway Process Assessment

- a. 1<sup>st</sup> gateway assessment (preliminary works): The developer, supported by the ESO, may submit a Needs Case for the Offshore Wider Works to Ofgem. Where a robust Needs Case is submitted, Ofgem makes commitments on approach to cost assessment on the rationale for Offshore Wider Works preliminary works.
- b. 2<sup>nd</sup> gateway process: The developer, supported by the ESO, may submit a Needs Case to Ofgem. Where a robust Needs Case is submitted, Ofgem make commitments on approach to cost assessment on the rationale for Offshore Wider Works construction works.
- c. Tender Exercise: The developer triggers a tender exercise Ofgem conducts a cost estimate and assessment, taking into account commitments at the 1<sup>st</sup> and 2<sup>nd</sup> gateway assessments.
- d. In the 2013 December consultation Ofgem proposed a number of high level criteria that would be used to evaluate gateway assessment submissions. These criteria included:
  - i. the (economic) Needs Case for investment
  - ii. the timing and scope of the project and its technical readiness
  - iii. proposals for ongoing ESO-developer engagement
- e. Gateway assessments will, in general, be expected to take place before a tender exercise has commenced. As the purpose of the gateway assessment is to inform a resulting tender exercise cost assessment, Ofgem expect the developer to be able to show their commitment to triggering a tender exercise for those assets before Ofgem undertake a gateway assessment.
- f. Timing of the Gateway process

- iv. In 2013 consultation Ofgem proposed providing flexibility in the timing of gateway assessments, driven by the needs of individual projects. The identified flexibility applied to the point at which the developer would trigger the gateway assessment, based on the developer's ability to provide sufficient information to enable Ofgem to conduct an informed assessment. Ofgem expect that early engagement between developers and Ofgem would inform the point at which the gateway assessment would be triggered.
  - v. Developers and the ESO will need to undertake analysis to provide an evidence of the feasibility and Needs Case for taking forward the Offshore Wider Works before considering triggering the first gateway assessment. Ofgem is considering that developers will generally only be able to satisfy the assessment criteria for the first gateway assessment after they have signed a BCA. Ofgem expect that in most cases there may need to be significant further engagement on connection optioneering between the developer and the ESO in order to inform a Needs Case submission. Ofgem also expect early engagement between developers and Ofgem will help inform when the gateway assessment should be triggered.
  - vi. Similarly, for the second gateway assessment, developers will be able to trigger the gateway assessment when they have sufficient information to enable Ofgem to conduct an informed assessment. Under the generator build option, Ofgem expect the timing of this gateway assessment to be as late as possible, to help ensure that the evidence provided in an offshore developer's submission remains up to date at the point at which significant final procurement decisions for the Offshore Wider Works are made.
- 5.17 Step 9: The ESO and offshore developers are providing support to Ofgem in the Gateway Assessment Process
- i. Ofgem will be working with the ESO and offshore developer to further develop what information for the gateway assessment process is required. The criteria and Needs Case requirements will be applicable to all projects, ensuring transparency of approach. However, given the unique technical requirements of offshore transmission and variation between projects, early engagement with developers ahead of a gateway assessment submission will provide an opportunity for Ofgem to provide further details on what information will need to be contained within an individual gateway assessment submission
- 5.18 Step 10: Ofgem approves the Developer Associated Offshore Wider Works project
- 5.19 Step 11: In collaboration with the offshore developer, the ESO makes sure that the developer's BCA remains in line with the outcome of Ofgem's gateway assessment process
- 5.20 Step 12: The Offshore developer delivers the project in line with the BCA.

Offshore Wider Works – Developer Associated process flow diagram

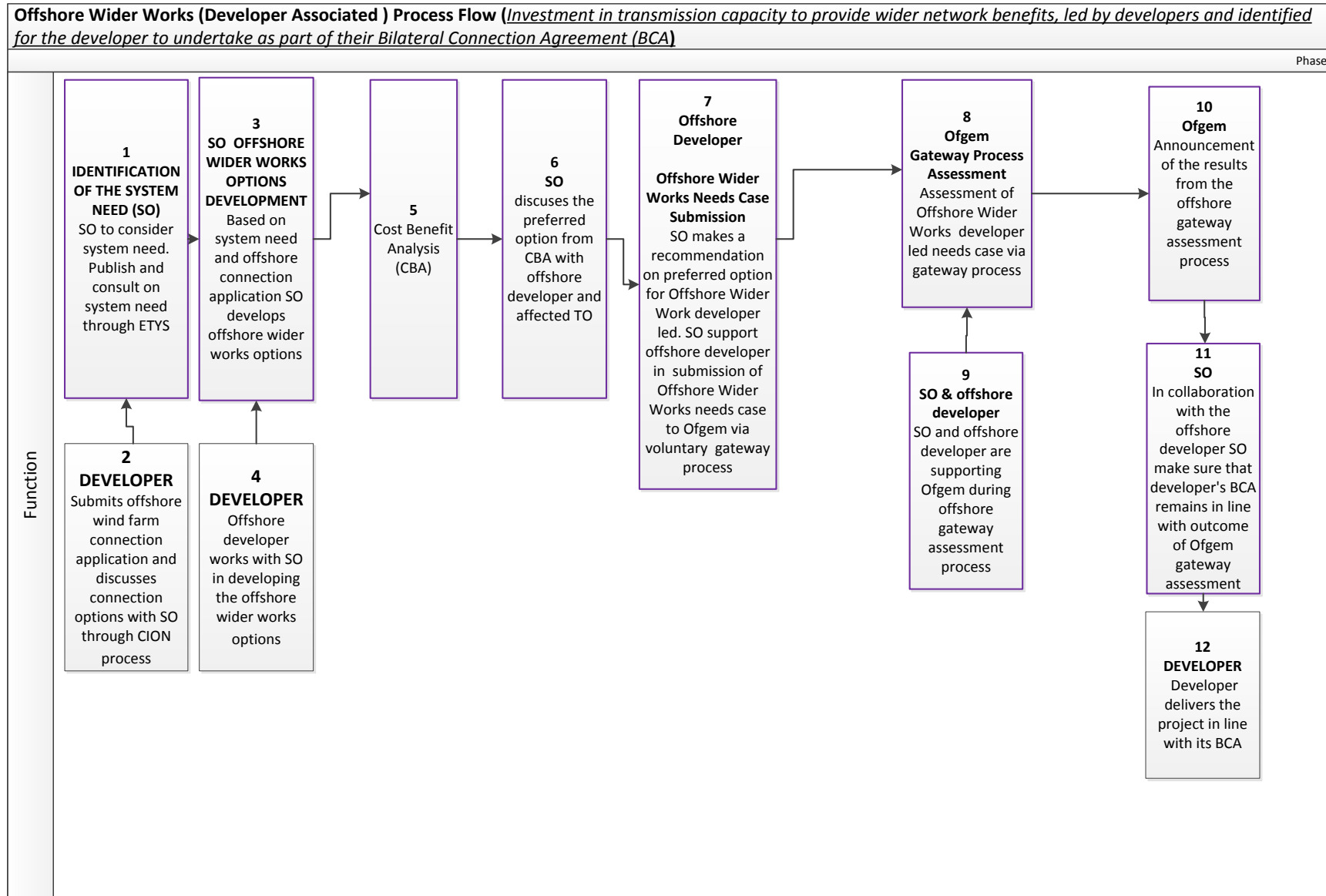

This diagram shows the overall Offshore Wider Works process. The text in each box corresponds to the descriptions of the stages explained in general process above. The numbers correspond to the step numbering in the text.



## Offshore Wider Works – Non Developer Associated overview

- 5.21 Current offshore transmission assets have been developed as standalone connections to shore known as radial connections. However, the Round 3 offshore wind projects are larger, more complex and at a greater distance from shore than those that have been developed so far. As a result there is likely to be the potential for efficiencies from greater coordination and integration of offshore transmission infrastructure. This could include coordination between offshore connections, and coordination of the strategic development of the wider network through offshore reinforcement projects.
- 5.22 Existing offshore transmission assets are designed as a radial links to allow the transfer of the power from the offshore generator to the onshore network, and are therefore the offshore asset rating is equal to the size of the wind farm. The Non Developer Associated Offshore Wider Works is investment that would support reinforcement of the wider transmission network, but where developers are unwilling or unable to take forward the offshore wider works. An Offshore Wider Works Non Developer associated Needs Case is in many cases a substitute for onshore wider works, and therefore is some way very similar to onshore wider works investment.

The regulatory route for Offshore Wider Works to be taken forward depends on the nature of the works to be carried out but could involve an OFTO build tender<sup>21</sup> run by Ofgem to identify an OFTO responsible for taking forward the works. Any development of a Needs Case for Offshore Wider Works should include discussion with Ofgem on the proposed nature of the works and the regulatory route for progressing those works.

---

<sup>21</sup> <https://www.ofgem.gov.uk/publications-and-updates/epc-contract-principles-of-to-build-tenders>

## Offshore Wider Works – Non Developer Associated process

- 5.23 The coordination of offshore transmission assets could reduce the costs of the onshore system reinforcement requirements and potentially reduce the costs for the end consumers.
- 5.24 A Non Developer Associated wider network benefit investment for Offshore Wider Works supports coordination of the development of offshore transmission assets and wider GB transmission network reinforcement. Offshore Wider Works Non Developer associated is not limited to a specific connection offer and is the case where offshore generators are unwilling or unable to take forward the offshore wider works.
- 5.25 The following text describe the steps of the ESO process for the Offshore Wider Works Non Developer Associated Needs Case.
- 5.26 Step 1: Identification of system need. The need for Non Developer Associated Offshore Wider Works will be identified by the ESO and the relevant TO. The system need for the Offshore Wider Works can be identified in the following ways:
- a. The ESO assesses the system need through the annual Electricity Ten Year Statement (ETYS) process, which subsequently informs the NOA Report.
  - b. The ESO and TOs regularly discuss and review network capacity issues and the need for network reinforcement in a particular TO's area at Joint Planning Committee (JPC) meetings. Based on that information a TO will consider Offshore Wider Options as an option to reinforce the network.
- 5.27 Step 2: ESO and relevant TO identify the Offshore Wider Works Options
- a. In collaboration with the relevant TO, the ESO develops the Offshore Wider Works options.
  - b. In developing Offshore Wider Works, the ESO will take into account two major transmission system design criteria: network capacity availability of local boundary and shortfall of the wider system boundaries.
  - c. According to Chapter 2 of the NETS SQSS – Generation Connection design, the transmission system is designed to accommodate 100% of the transmission entry capacity at the connection point within a local boundary (e.g. for 1GW wind farm connection, the onshore system is designed to accommodate the complete 1GW generation and the offshore assets are sized to provide this full transmission entry capacity.)
  - d. In planning the Main Interconnected Transmission System (MITS) however, different scaling factors are applied to different types of generating. In the case of wind, this implies that the assets are not assumed to be 100% utilised by the wind generated. Taking into account all these scaling factors, the offshore infrastructure is allowing some spare capacity in the assets. It is this 'spare' capacity that provides the opportunity for offshore wider works to be utilised as one of the options to provide boundary capability.
  - e. In providing the Offshore Wider Works design it is crucial the ESO and affected TO work together and agree on the generation background, scenarios, and sensitivities which will be used as a basis for the Offshore Wider Works designs. In this stage, the ESO will inform Ofgem on the agreed background and scenario which will form the basis for the Offshore Wider Works designs.
  - f. The benefits of the Offshore Wider Works will be also assessed by utilising a combination of operational actions to maximise the capability across the boundaries (e.g. actions included QB optimisation and redirection of flows in HVDC links).
  - g. Once the ESO and the affected TO agree on the Offshore Wider Works options, the agreed Offshore Wider Works options are progressed into the cost-benefit analysis.
- 5.28 Step 3: Cost-benefit analysis. The ESO will perform the cost-benefit analysis on the agreed Offshore Wider Works options from Step 2. The ESO will lead the cost-benefit analysis.
- 5.29 The Cost-benefit analysis will be performed by the ESO and the objectives and scope of the cost-benefit analysis is explained below:

- a. The key economic objectives for cost-benefit analysis for Offshore Wider Works are:
  - i. Ensure value for money for the consumers by delivering cost effective reinforcements to ensure economically efficient design and operation of the network.
  - ii. Timely delivery of necessary reinforcement(s) to minimise any cost exposure for consumers to either early investment or delayed implementation.
- b. The objectives for Offshore Wider Works cost-benefit analysis are:
  - i. To be consistent with Licence obligations and National Electricity Transmission System (NETS) Security and Quality of Supply Standards (SQSS), the analysis promotes economic and efficient investment.
  - ii. To present economic justification for the preferred Offshore Wider Works designs and an explanation of how they compare with the alternative counterfactual case.
  - iii. To present evidence on expected long-term value for money for consumers considering a range of sensitivities
  - iv. To present evidence on optimal timing of the preferred reinforcement option.
- c. Driven by these objectives the scope of the cost-benefit analysis is:
  - i. To establish the reference case position in terms of constraint costs forecasts associated with the 'do minimum' network state, across different generation background scenarios.
  - ii. To model the economic impact, measured as constraint cost savings, for a range of designs, across a range of scenarios.
- d. To undertake a cost-benefit analysis by:
  - i. Appraising the economic case of the options by adopting the Spackman<sup>22</sup> approach and determining respective Net Present Values (NPVs) across the studied generation scenarios and sensitivities.
  - ii. Establishing worst regrets associated with each design/technology appraised.
  - iii. Identifying the Least Worst Regret option overall
  - iv. Assessing the impact of key sensitivities: increase in capital expenditure, and delays in delivery timeframes.
  - v. Make recommendations for the preferred option i.e. the Least Worst Regret solution, taking into consideration the impact of sensitivities.

---

<sup>22</sup> The Joint Regulators Group on behalf of UK's economic and competition regulators recommend a discounting approach that discounts all costs (including financing costs as calculated based on a Weighted Average Cost of Capital or WACC) and benefits at the Social Time Preference Rate (STPR). This is known as the Spackman approach. Further details of our assumptions regarding WACC and STPR are presented later in this document.



# 6

## ESO process for High Voltage and Stability Management



High voltage and stability management are two separate processes with different technical assessments. However, they share a number of similarities in the economic assessment and tender processes and have therefore been combined into one section.

### Overview of the High Voltage and Stability Management Process

6.1 The objective of the process is to ensure economical and efficient options for high voltage and stability management will be available when required. This Electricity System Operator (ESO) led process is designed to identify high voltage and stability issues in the transmission system, the causes, requirements and the preferred options to solve these issues. The process is designed to work with all expected option providers including Transmission Owners (TO), Distribution Network Owners (DNO) and Commercial Service Providers. *Figure 6.1* gives an overview of the high voltage and stability management process.

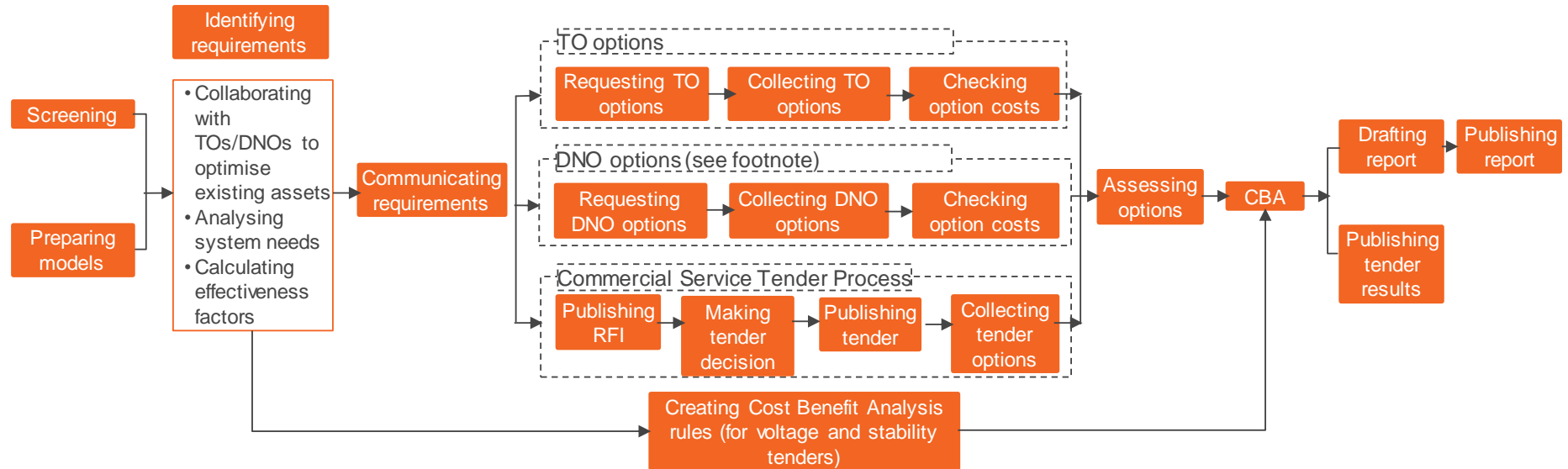

Figure 6.1 Overview of the high voltage and stability management process<sup>23</sup>

<sup>23</sup> In the long term when a regulatory funding mechanism for DNO options is agreed, it is expected that DNO options will follow a similar route as TO options, but presently a suitable regulatory funding mechanism is not in place for the DNO options. Until a suitable funding mechanism is established it is expected



## Programme

- 6.2 The ESO carries out the screening process annually. The ESO anticipates to carry out the screening process after the annual technical analysis of boundary capabilities for ETYS & NOA.
- 6.3 Detailed assessment of any prioritised regions will be initiated on demand and as agreed between the ESO and the relevant TOs and DNOs.
- 6.4 Timeline of the detailed assessment of any prioritised regions will vary depending on the complexity and the size of requirements. The ESO will agree the timeline with the relevant TOs and DNOs involved.

---

that the DNO options will be paid via the Balancing Service Contract; hence DNO options will follow the same route as Commercial Service options in the short term. The stability solutions are expected to be more effective at the higher voltage levels due to network impedance and therefore the DNO options may not be applicable.

## Roles and responsibilities

### System Operator

- 6.5 National Grid Electricity System Operator (ESO) leads the high voltage and stability management processes. ESO shall be responsible for:
- Plan develop and operate the NETS in accordance with the SQSS
  - Selecting and prioritising regions by screening
  - Preparing network models for analysis
  - Collaborating with TOs and DNOs to identify requirements
  - Communicating requirements to providers
  - Collecting options from providers
  - Assessing options
  - Collaborating with DSO<sup>24</sup> to carry out the technical assessment of distribution-connected options
  - Recommending options based on cost-benefit analysis
  - Communicating process conclusions to providers
  - Procuring Commercial Power Services via Balancing Service Contract
  - Publishing the high voltage and stability management process Reports.

### Transmission Owners

- 6.6 Transmission Owners (TO) shall be responsible for:
- Plan and develop their networks in accordance with the SQSS
  - Providing feedback on regions which they think should be prioritised in this process
  - Preparing network models for analysis
  - Collaborating with ESO to explore options from existing assets of their networks for analysis
  - Collaborating with ESO to identify requirements
  - Supporting the assessment of options which could have an impact on their network
  - Proposing options using the System Requirement Form – Voltage/Stability.

### Distribution Network Owners

- 6.7 Distribution Network Owners (DNO) shall be responsible for:
- Compliance of their networks
  - Preparing network models for analysis
  - Collaborating with ESO to explore options from existing assets of their networks for analysis.

DNOs shall also be responsible for the following, while the relevant DSO does not yet exist:

- Collaborating with ESO to identify requirements
- Supporting the calculation of effectiveness factors for their networks
- Collaborating with ESO to carry out the technical assessment of distribution-connected options which connect to their networks.

DNOs will be invited to respond to any Request for Information and/or participate in any Tender Process. They can propose options which meet requirements set out by ESO via the Tender Process<sup>25</sup>.

---

<sup>24</sup> Where a relevant DSO function does not yet exist, it is expected that the relevant DNO will take responsibility.

<sup>25</sup> In the long term when a regulatory funding mechanism for DNO options is agreed, it is expected that DNO options will follow a similar route as TO options, but presently a suitable regulatory funding mechanism is not in place for the DNO options.

## Reactive Power and Stability Commercial Service Providers

- 6.8 Reactive Power and Stability Commercial Service Providers will be invited to respond to any Request for Information and/or participate in any Tender Process. They can propose options which meet requirements set out by ESO via the Tender Process.

## Principle of assessment for high voltage and stability issues related investment

- 6.9 The ESO plans, develops and operates the transmission system so that voltage and frequency levels stay within the normal operating ranges defined within the National Electricity Transmission System Security and Quality of Supply Standards (NETS SQSS)<sup>26</sup>. The specific voltage and frequency limits used in planning and operating the transmission system can be found in chapter 6 of the NETS SQSS.
- 6.10 To ensure the ESO can plan the system to operate securely and safely while managing voltages and system stability both economically and efficiently, a Network Options Assessment (NOA) style methodology is proposed. This will facilitate the assessment of options to develop the electricity networks to meet future voltage and stability control requirements.

### High Voltage Assessment

- 6.11 In terms of voltage control requirement, an immediate need is being seen for high voltage control, so the initial focus will purely be on managing high voltages. This will be an expansion to the existing NOA methodology which primarily focuses on thermal and low voltage issues that are typically seen when power transfer across the network is high. This is normally assessed at peak demand periods. High voltage issues are typically encountered during period of light system loading or minimum demand.
- 6.12 Other voltage control concerns are present but to avoid increased complexity and delay they are not being addressed in this methodology. As the NOA methodology continues to evolve, the ESO will expand the methodology to cover further voltage control concerns in the future.
- 6.13 High voltage issues are typically confined to relatively small areas and voltage control solutions are usually ineffective over long distances so the ESO will apply a regional approach to the assessment.
- 6.14 The ESO uses cost-benefit analysis (CBA) to provide investment recommendations. Cost-benefit analysis compares the cost of a proposed solution and the monetised benefits over the project's life to inform the investment recommendation. To effectively meet the future voltage control requirement, the ESO also considers system operability when recommendations are made. The two primary factors that will drive an ESO recommendation are:
- a. **Monetised benefits**, when monetised benefits are higher than the forecast solution cost. This implies investing in the proposed solution will provide a more economical and efficient way to manage voltages in the long term when compared to the ESO paying for reactive power service in real-time via the Balancing Mechanism (BM).

#### Justification based on monetised benefits

The monetised benefits are the cost saving achieved by investing in a proposed solution compared to using existing services such as Obligatory Reactive Power Services (ORPS)<sup>27</sup>. The ESO currently relies heavily on the reactive power capabilities of generators for managing voltage. The ESO hopes to see savings on constraint cost and, in some cases, utilisation cost as well. To estimate this saving, the ESO forecasts the constraint and utilisation costs they will pay for accessing and using the ORPS via the BM.

---

<sup>26</sup> Transmission Licence Standard Conditions C17: Transmission system security standard and quality of service, Paragraph 1

<sup>27</sup> The Obligatory Reactive Power Service (ORPS) is the provision of varying reactive power output. At any given output generators may be requested to produce or absorb reactive power to help manage system voltages close to its point of connection. All generators covered by the requirements of the Grid Code are required to have the capability to provide reactive power.

Constraint cost refers to the bid and offer price the ESO pays (for the MW) to get a generator onto the system to provide reactive power support, together with another generator reducing its generation or turned off elsewhere on the system to maintain the balance of supply and demand. Utilisation cost refers to the payment the ESO makes (for the MVar) to generators for using their reactive power capabilities, the more being used the higher the cost.

The aim here is to find the solutions which deliver additional benefits to the consumers, in the form of net savings. This is achieved by replacing services which will need to be procured via the BM with lower cost proposed options. *Figure 6.2* shows how proposed options replace services from the BM to meet the voltage control requirement. The ESO uses cost-benefit analysis (CBA) to compare forecast investment costs and monetised benefits over the duration of the system need to inform this investment recommendation.

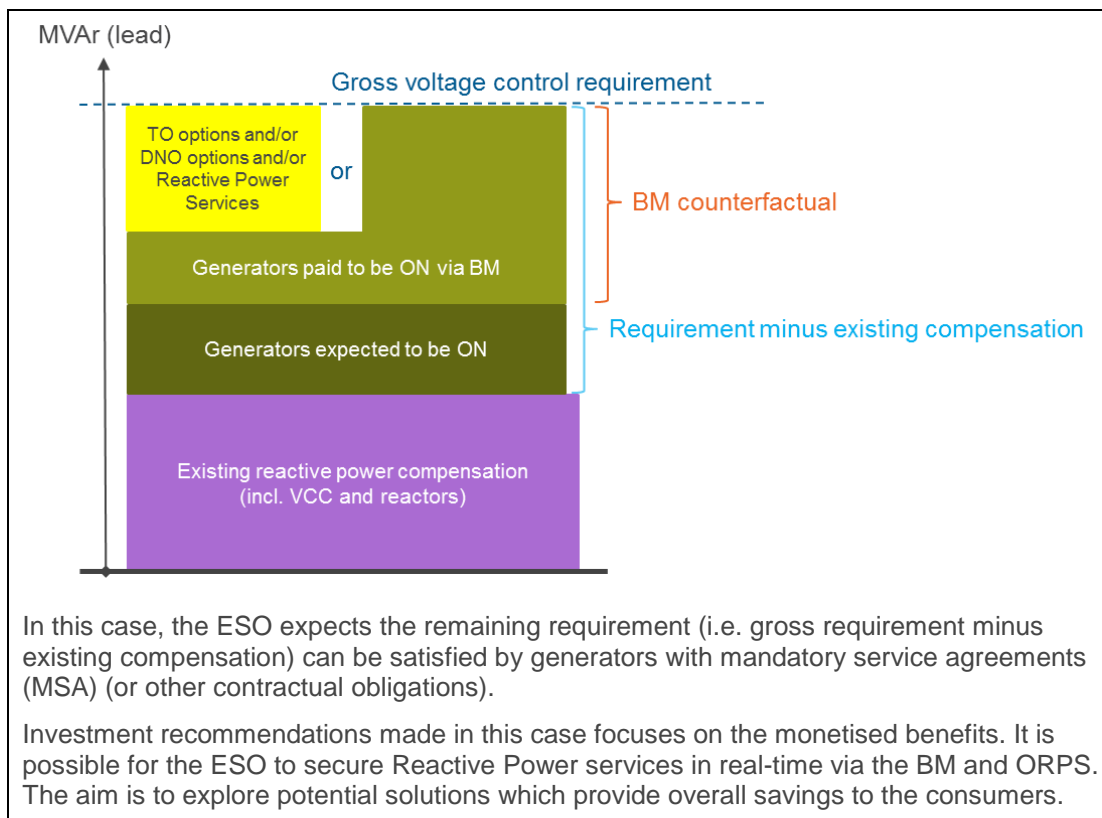

Figure 6. 2 Proposed options replacing services from the BM to meet voltage control requirement

- b. Operational security requirement, when there are insufficient means to provide reactive power to contain high voltages and securely operate the network. This implies the forecast reactive power required in the future is higher than is forecast to be available via the BM or other means.

Justification based on security and operability

Given the rapid changes in generation and demand backgrounds, there may be times in the future where there will be insufficient reactive power compensation or services available to meet the voltage control requirements within a region. If such situation is observed in the analysis, the ESO will then focus on verifying the credibility of the assumptions leading to such a situation. If deemed credible, the most cost effective solution to resolve the situation will be pursued. *Figure 6.3* shows how proposed options provide the reactive power needed to meet voltage control requirement as sufficient services cannot be procured from the BM.



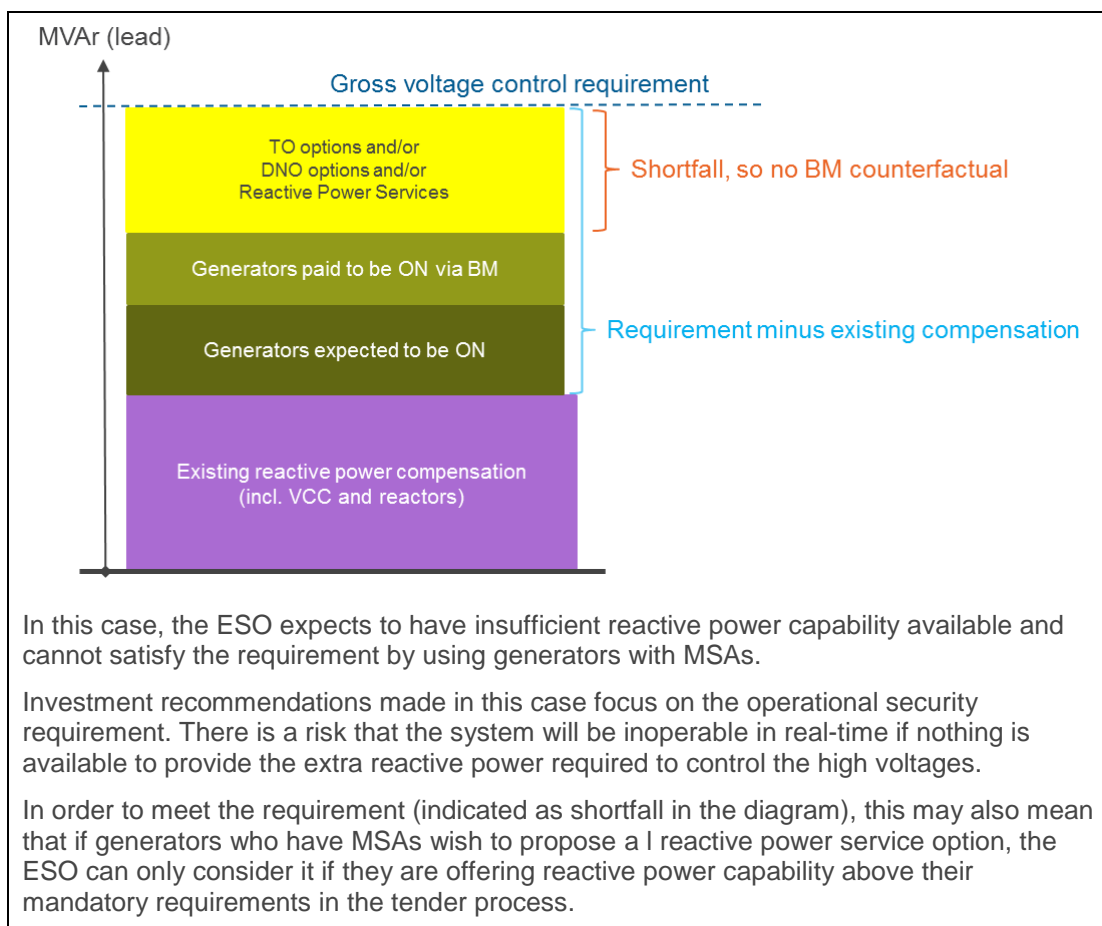

Figure 6.3 Proposed options providing the reactive power needed to meet voltage control requirement as sufficient services cannot be procured from the BM

## Stability Assessment

- 6.15 Voltage and frequency limits used in planning and operating of the transmission system are stated in the NETS SQSS. The GB Grid code defines performance requirements for different users connected the National Electricity System for different system conditions (e.g. fault ride through requirements, voltage and frequency withstand variations).
- 6.16 The ESO considers stability at national level where solutions' ability to provide stability support is independent of its electrical location. The ESO also considers stability on a regional basis where both the need and the solutions are location specific. There will be some interaction between these two types of needs that the ESO will manage in communicating the requirements.
- At a national level, ESO maintains system frequency within limits by consideration of frequency response/reserve market products and maintains Rate of Change of Frequency (RoCoF) within limits by consideration of largest generation/demand loss on the system and planning for national levels of inertia.
  - At a regional level, the distribution of regional inertia, short circuit level, dynamic voltage support can influence the stability of the local network and its users.
- 6.17 Similar to Voltage assessment, in order to ensure the system is planned in a way that it could be operated securely and safely while system stability is managed both economically and efficiently, a Network Options Assessment (NOA) style methodology is proposed. This will facilitate the assessment of options to develop the electricity networks to meet future stability requirements.

6.18 The ESO uses a cost-benefit analysis (CBA) to provide investment recommendations. The cost-benefit analysis compares the cost of a proposed solution and the monetised benefits over the length of the system need to inform the investment recommendation. The two primary factors that will drive an ESO recommendation are:

- c. **Monetised benefits**, when monetised benefits are higher than the forecast solution cost.

This implies investing in the proposed solution will provide a more economical and efficient way to manage stability in the long term when compared to the ESO paying for the equivalent services in real-time via the Balancing Mechanism (BM).

#### Justification based on monetised benefits

The ESO currently relies on the inherent capabilities of synchronous generators participating in the BM to provide inertia, short circuit current and dynamic voltage support. The ESO takes actions in the BM to address any shortfall which would lead to system instability. The ESO hopes to see savings on constraint costs. To estimate this saving, the ESO forecasts the constraint and utilisation costs they will pay for accessing and using the short circuit level and inertia via the BM.

Constraint cost refers to the bid and offer price the ESO pays (for the MW) to get a generator onto the system to provide stability support, together with another generator reducing its generation or turned off elsewhere on the system to maintain the balance of supply and demand.

The aim here is to find the solutions which deliver additional benefits to the consumers, in the form of net savings. This is achieved by replacing services which will need to be procured via the BM with lower cost proposed options. In some future instances, the ESO expects a shortfall in the BM to procure for stability. **Figure 6.4** shows how proposed options replace services from the BM to meet stability requirement. The ESO uses cost-benefit analysis (CBA) to compare forecast investment costs and monetised benefits over the solution's life to inform this investment recommendation.

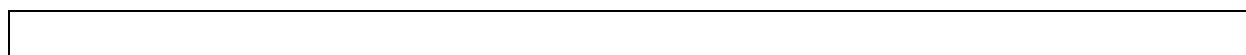

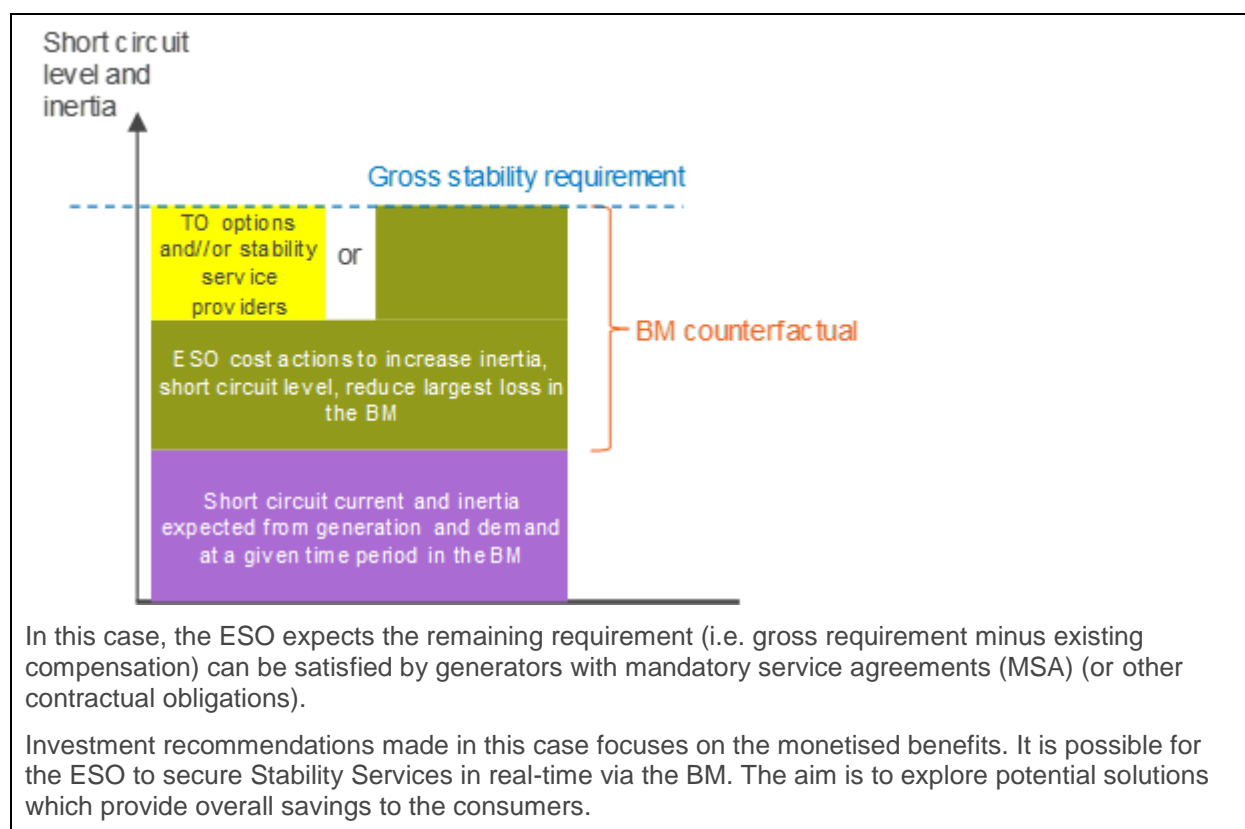

Figure 6. 4: Proposed options replacing services from the BM to meet stability requirement

- d. Operational security requirement, when there are insufficient means to provide stability support and securely operate the network. This implies the forecast stability requirement in the future is higher than is forecast to be available via the BM or other means.

#### Justification based on security and operability

Given the rapid changes in generation and demand backgrounds, there may be times in the future where there will be insufficient BM services available to meet the stability requirements within a region. If such situation is observed in the analysis, the ESO will then focus on verifying the credibility of the assumptions leading to such a situation. If deemed credible, the most cost effective solution to resolve the situation will be pursued. *Figure 6. 5:* shows how proposed options provide the stability requirement as sufficient services cannot be procured from the BM.

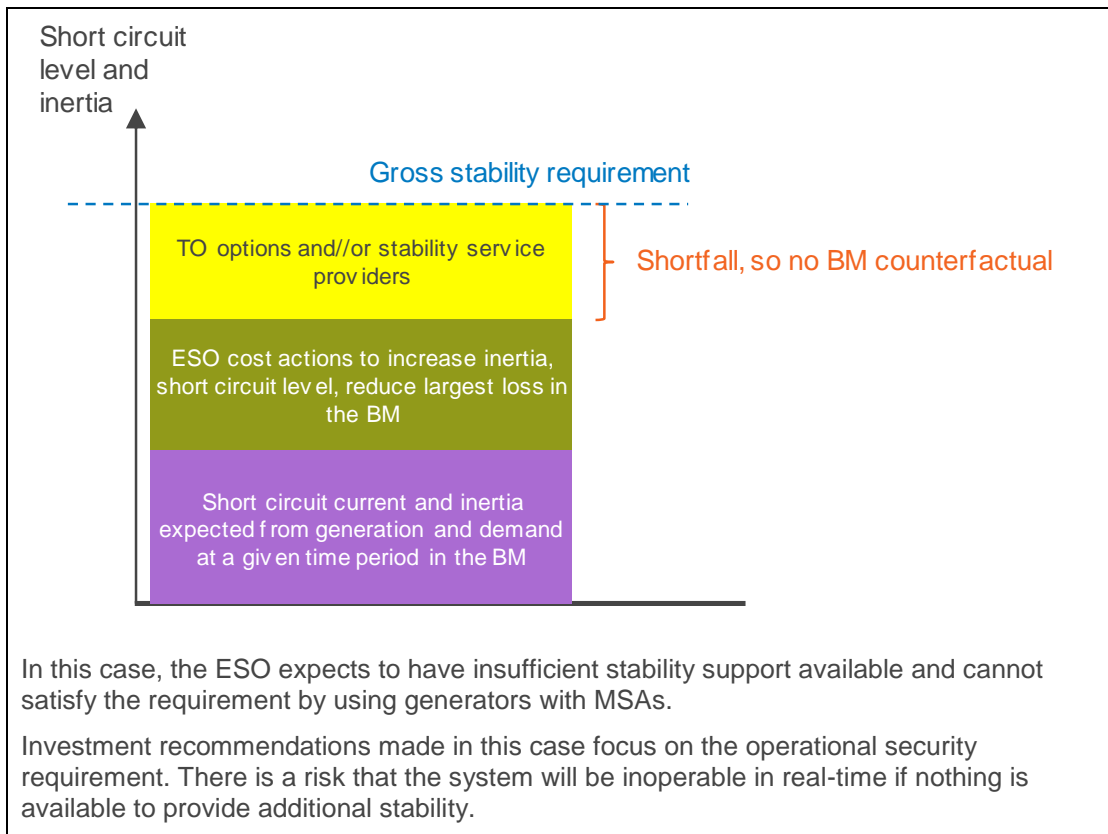

Figure 6. 5: Proposed options providing the stability support needed to meet requirement as sufficient services cannot be procured from the BM

6.19 Investment recommendations will be based on the above mentioned two primary factors. As a general principle, if there are several options which meet the requirements and satisfy either of the two primary factors, the CBA chooses the most economical and efficient options. This is described in more detail in the section “Cost-benefit analysis”.

## The High Voltage management process

### Regional approach – determining the most economical and efficient solution for High Voltage management Process

- 6.20 Voltage is a localised property of the system which means that requirements vary from one region to another. The voltage control requirements are determined by the configuration of the local network and the nature of generation and demand in that region. Since reactive power, unlike real power, cannot be sent across long distances due to the reactance of the transmission network, voltage control is most effective when applied close to the problem. Voltage issues can therefore be grouped into regions and assessment of each region conducted separately. The high voltage management process looks into the reactive power required for high voltage control on a regional basis.

### Screening process – selecting and prioritising regions

- 6.21 The ESO uses a screening process to help identify and prioritise the region(s) which should be further explored through detailed power system and cost-benefit analysis. This should bring consumers the best value by ensuring that the secure, economical and efficient development of the network focuses on challenging regions first. The screening process considers four main factors which are in line with the NOA assessment principles – cost, network change, likelihood and lead time.
- Cost: The focus is on the historic spend in each region to procure Commercial services for managing high voltages. A high historic spend in a region suggests heavy reliance on the BM and ORPS, which suggests potential benefits of conducting an assessment to evaluate the best options to provide future reactive support in the region.
  - Network change: This refers to any significant changes of the system in the future, including new generation (including embedded generation), major generator closures, commissioning of new cables etc. Regions which do not associate with a high historic spend, but which are set to see some significant changes that contribute to an increasing need for reactive support should be assessed.
  - Likelihood: This is an assessment about how likely the above two factors will materialise. For example, if the high historic spend was due to a routine maintenance outage, it will be considered more likely than spend due to a long outage caused by a fault.
  - Lead time: This refers to the length of time between the system need and the typical lead time to deliver an option in the region of interest. For example, if a compliance concern will arise soon after any options can be sourced to meet the requirements, there is an urgency to assess the region.
- 6.22 The ESO will request feedback from the TOs as to which region(s) they believe should be assessed. This includes any compliance concerns in their networks.
- 6.23 The ESO will discuss any compliance concerns raised by the TOs and agree a plan to assess these concerns. The discussion will consider when the compliance issue may materialise and the lead time of potential options to resolve the issue.
- 6.24 The four factors mentioned above in 6.18, together with the TOs' feedback, will be used to help determine the region(s), as well as the backgrounds and conditions that the ESO will consider in the assessment. For example, conditions which are associated with high historic spend and are expected to persist or grow in severity will be analysed. The ESO will apply these conditions to future backgrounds which show similar characteristics to the system when those high historic spends arose.

### Creating network models for analysis

- 6.25 In this high voltage Management Process, the ESO will use the GB system planning models produced in accordance with the SO-TO Code (STC) . Future backgrounds based on Future Energy Scenarios (FES) and system conditions considered appropriate in accordance with the NETS SQSS will be applied to the models for assessment.



6.26 TOs and DNOs will provide relevant data to support the ESO in preparing the models for analysis.

### Identifying requirement

#### Collaborating with TOs/DNOs to explore options from existing assets

6.27 The ESO collaborates with Network Owners, TOs and DNOs, to ensure a consistent methodology is applied when it comes to planning and developing the transmission system. TOs are obliged by their transmission license to plan and develop their transmission network in accordance with the NETS SQSS. DNOs have a key role in enabling a whole system approach to address some of the future requirements in the transmission system while maintaining compliance of their distribution system.

6.28 The ESO shares the initial view of areas of priority with the relevant TOs and DNOs. The ESO aims to ensure consistent methodology, models, backgrounds and sensitivities are considered across all analyses. TOs and DNOs provide feedback about their networks in the relevant areas. The feedback will help the ESO to optimise existing assets prior to quantifying the system needs in those areas in details. To ensure the transmission system is planned and developed in an economical and efficient manner, the ESO should only proceed with new requirements once existing network assets are optimised.

6.29 Where available, the ESO engages with the system operator function of the distribution companies.

#### Analysing the size of the reactive power requirement

6.30 The ESO identifies the reactive power required to control voltage based on system analysis results. The requirement varies depending on the future backgrounds and system conditions. It is not practical to fully analyse all combinations of backgrounds and conditions. Hence, the ESO selects snapshots using historic records assisted by data mining techniques and engineering judgement to represent a reasonable number of variations of backgrounds and conditions. The same four factors, which were considered during the screening stage (i.e. cost, network change, likelihood and lead time), are used to help with the selection.

6.31 The ESO collaborates with the TOs and DNOs to identify the reactive power required for the transmission networks.

6.32 The diagram below illustrates how the analysis to identify the reactive power required may be structured. The example shows variation in demand assumptions. The selection of the specific study backgrounds and system conditions, which set out the analysis, however depends on the characteristics of the region of interest.

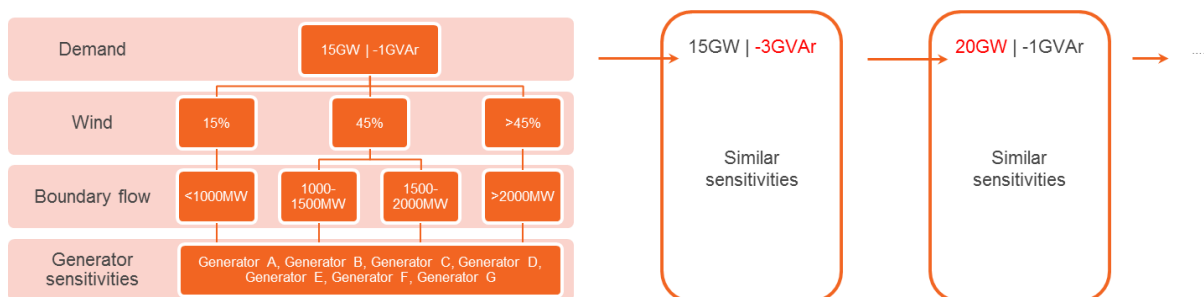

Figure 6. 6 Example of backgrounds and conditions considered for analysis

6.33 The reactive power required depends on what the ESO expects the system will need in the future to maintain voltages within the NETS SQSS limits. To determine the reactive power required for any region of the network the following steps are applied:

1. Set up analysis with selected credible backgrounds and system conditions
2. Analyse to check if the NETS SQSS requirement can be met with existing reactive power compensation and generators which are predicted to run
3. If the NETS SQSS requirement can be met, note the generators running in the region of interest and move on to the next sensitivity analysis

4. If the NETS SQSS requirement cannot be met
    - a. If applicable, consider using different combinations of generators in the region of interest which are accessible via the BM
      - i. Simulate constraint (bid and offer) actions until the voltage control requirement is satisfied
      - ii. Note the generators running in the region of interest
    - b. Consider suitable transmission solutions
      - i. Simulate investment in new transmission assets at different locations until the voltage control requirement is satisfied
      - ii. Note the size of new reactive power compensation plant(s) required and the location they are connected at. This is used to define the reactive power required and the most optimum location for solutions to meet the need in the region
    - c. Continue to the next analysis
- 6.34 The recorded generators running under each analysis will be used to formulate the voltage rules. This is described in more detail in the section “*Creating voltage rules*”.

### Calculating effectiveness factors

- 6.35 To allow a fair comparison to be made for all potential options, effectiveness factors are used when the ESO assesses options. The effectiveness of an option is directly linked to its point of connection and determines the amount of reactive power required to meet the requirement. This will change the total volume expected to be invested or procured. For example, if a unit A was assessed to be 50% effective and unit B 100% effective, to resolve the same issue the system would need to use twice as much reactive power from unit A than B. Unit A would need to be significantly cheaper to have the same benefits.
- 6.36 Effectiveness changes with certain system conditions, for example with certain outages. The ESO calculates effectiveness factors for each point of connection against consistent (set of) background to ensure all providers are treated equally.
- 6.37 The examples below are all aimed to be illustrative and provides approximations of potential differences in effectiveness. This will change when specific technical assessment for each region is completed. Provider A in green, Provider B in red.

#### Example 1

Provider A and B are connected at the same site. The site is run solid. The two different providers have similar reactive ranges.

The providers would likely have the same effectiveness factor.

Note: If the site is run split, the providers would likely have different effectiveness factors.

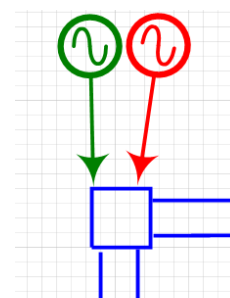

Figure 6. 7

Example 2

Provider A and B are connected at different, adjacent, sites, but sites that are geographically close together.

The providers would likely have similar effectiveness factors.

Note: Distance in the diagram is indicative only.

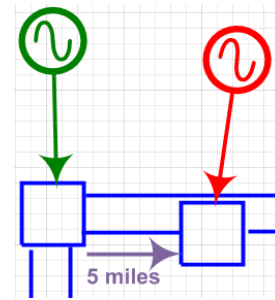

Figure 6. 8

Example 3

Provider A and B are connected at different, adjacent, sites, but sites that are geographically far apart.

The providers would likely have different effectiveness factors.

Note: Distance in the diagram is indicative only.

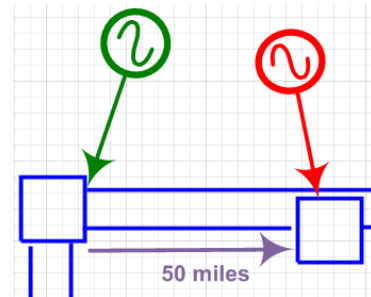

Figure 6. 9

Example 4

Provider A and B are connected at different voltage levels. Provider B is connected at 132kV in the DNO network.

The ESO expects the options close to the source of the issue will have higher effectiveness factors.

If, for example, the source of the issue is at the transmission network, then Provider B that is connected at a 132kV voltage level is likely to be less effective than Provider A. Providers connected at lower voltages than 132kV, in this example, would be expected to be even less effective.

Alternatively, if, for example, the source of the issue is at the distribution network<sup>28</sup>, then Provider B is likely to be as effective (or more effective in some cases) than Provider A.

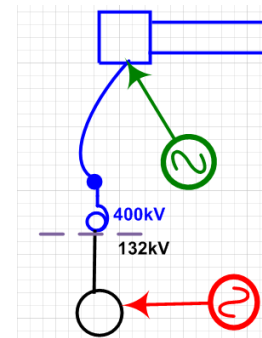

Figure 6. 10

Example 5

The reactive power required is set specifically for a defined region. The region has been defined based on potential effectiveness.

Provider A is inside the defined region and Provider B is outside the defined region.

Providers outside the region are assessed as only being ineffective at resolving the issue.

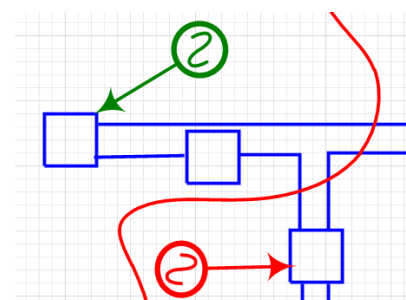

Figure 6. 11

<sup>28</sup> The [Power Potential Project](#), which aims to create a new reactive power market for distributed energy resources (DERs), will provide further insights into effectiveness of options connected to the distribution network. The ESO will learn from the Project and continuously improve their understanding of effectiveness.

- 6.38 Many factors affect the effectiveness of an option, such as its size, where and how it will connect to the network. Effectiveness factors are relative to a reference point in the network. The ESO chooses reference point(s) in the network based on where it is most effective to implement reactive power compensation to meet the requirement of the region of interest. Through system analysis the ESO calculates the effectiveness of various available transmission-level connection points with respect to the reference point(s).
- 6.39 For distribution-level connection points, the ESO works with the relevant DNOs to calculate the effectiveness factor of an option. The DNO will calculate the impact of a distribution-connected option to the closest GSP(s). With this information, the ESO can then calculate the effectiveness factor of a distribution-connected option with respect to the reference point in the transmission network. Where available, the ESO engages with the system operator function of the distribution companies.
- 6.40 In an example below, system analysis suggests it is most effective to implement reactive power compensation at substation Y and that 100MVAR of reactive power absorption is required to meet the system requirement.

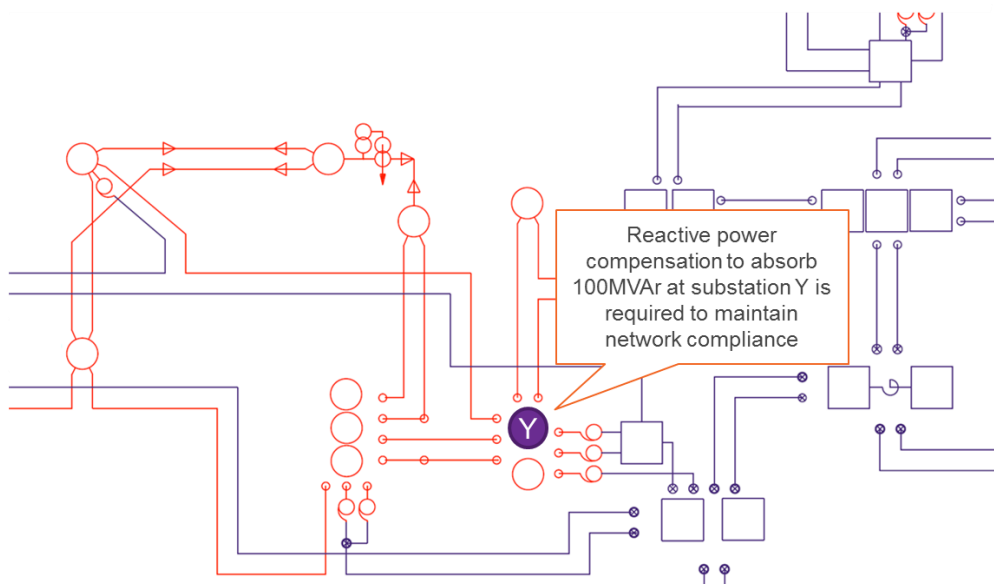

Figure 6.10

- 6.41 Next, the ESO calculates the effectiveness for options connecting at substation Z with substation Y as the reference point. The ESO models reactive power compensation to absorb 100MVAR at substation Z and test it with selected backgrounds and conditions. In this example, analysis results show that (on average) implementing a reactive power compensation to absorb 100MVAR at substation Z reduces the compensation required at substation Y from 100MVAR to 25MVAR.

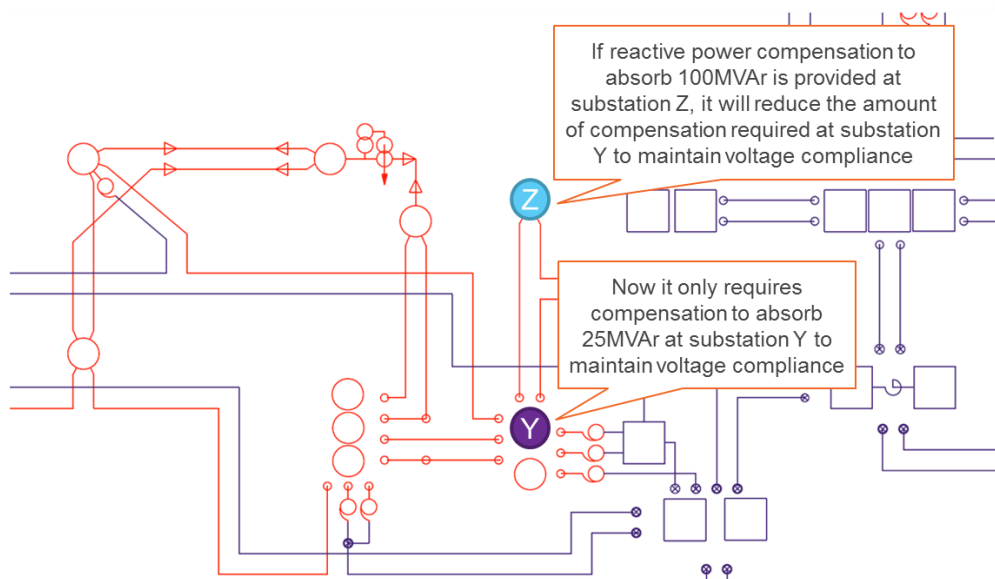

Figure 6.11

- 6.42 The ESO can then approximate the effectiveness for any options connecting at substation Z as  $(100-25)/100 = 0.75$  with respect to the reference point.

$$\text{Effectiveness factor} = \frac{\text{original compensation at ref. point Y} - \text{resulting compensation at ref. point Y}}{\text{size of option at Z}}$$

### Communicating requirements

- 6.43 The reactive power required to control voltage will be communicated to relevant parties in the form of “equivalent reactive power compensation to absorb X MVar at location Y”.
- 6.44 The ESO also provides information on the effectiveness of reactive power compensation or services installed away from location Y. This information could be presented in a heatmap. All effectiveness factors are relative to the same reference point(s). This is most likely to be the same reference point(s) stated in the requirement i.e. “location Y” for consistency.
- 6.45 The ESO will provide the same information on requirement to all potential option providers. Such information will be provided to the TOs using the System Requirement Form – Voltage (SRF-V). This uses a similar format and structure as the SRF used in the current NOA for network boundary flow. The same information will be provided to the DNOs and Commercial service Providers via the Tender Process.
- 6.46 For the avoidance of doubt, this does not imply other information which the TOs and DNOs currently have access to in accordance with the likes of SO-TO Code (STC) or Connection and Use of System Code (CUSC) for network planning purposes will be provided to all parties due to confidentiality reasons.

### Requesting & collecting options

- 6.47 The ESO will invite potential solution providers including TOs, DNOs and Commercial Service Providers to propose options to meet the reactive power for voltage control requirements.
- 6.48 Any parties interested to have their options considered by the ESO should respond to the invitation to propose options.
- 6.49 The TOs should respond using the SRF-V while the DNOs and Commercial service Providers should respond via the Tender Process.
- 6.50 For the avoidance of doubt, all options received will be assessed against each other using the same criteria. The different submission process reflects the difference in funding mechanisms - TO options will be recovered via the present transmission regulatory framework, while DNO and Commercial service options will be paid via the Balancing Service Contract. The ESO



considers and assesses all options in the same CBA. See the section “Cost-benefit analysis” for more details.

6.51 The option collection process for each party is as follows:

#### **Branch 1 – TO options**

The exchange of option information between the ESO and the TOs will be by means of the System Requirement Form – Voltage (SRF-V). The outline of the SRF-V structure is shown in Table 6.1.

Table 6. 1 Outline of System Requirement Form - Voltage

SRF-V Part	Section title	Details
A	Requirement	Information on requirement in SRF-V Part A will be the same as the information published as part of the Request for Information (see Branch 3 for more details).
B	TO proposed options	TOs provide the information on their proposed options.
C	Outage requirement	TOs provide the expected outages required to connect new assets associated with their proposed options.
D	Not applicable	N/A
E	Option costs	TOs provide the costs on their proposed options. Information should include, but is not limited to:  Capital cost, annual breakdown of cost, operation & maintenance cost, WACC etc.
F	Publication information	TOs specify the information which they give consent to the ESO to publish. The ESO will request consent from the TOs to publish the same level of information consistent with the way information from a DNO option or a Commercial service option will be published when the Tender Process concludes.

6.52 System requirements are sent to the TOs using SRF-V Part A. Unless stated otherwise, this also acts as the prompt to the TOs to propose options.

6.53 TOs are expected to submit their options to the ESO using SRF-V Part B, Part C and Part E. All costs supplied in the submission should be in current financial year base prices. SRF-V Part D is not used in the high voltage and stability management process.

6.54 The SO reviews the costs that the TOs submit with their options and check that they are reasonable. The SO checks the costs that the TOs submit against a range of costs for plant and equipment that the ESO has gained from recent experience. If any costs are outside of the range, the SO discusses the costs with the relevant TO. If, following discussions the ESO still believes that the costs are outside of the expected range and will unduly affect the CBA, the ESO can omit the option from the CBA.

#### **Branch 2 – DNO options**

6.55 In the long term when a regulatory funding mechanism for DNO options is agreed, it is expected that DNO options will follow a similar route as TO options, but presently a suitable regulatory funding mechanism is not in place for the DNO options. Until a suitable funding mechanism is established it is expected that the DNO options will be paid via the Balancing Service Contract; hence DNO options will follow the same route as Commercial service options in the short term. Therefore, DNOs who wish to propose options should respond via the Tender Process.

#### **Branch 3 – Commercial Service Tender Process**

6.56 The ESO publishes the requirements to inform potential Commercial service Providers as part of a Request for Information (RFI). This includes the technical requirements which a

Commercial service must meet to participate in the Tender Process. The ESO uses the RFI to gather information about options that could relieve the high voltage and stability issues. Where applicable, the ESO may directly proceed with a tender process without an RFI. In general, the ESO would like to understand the following before a decision to tender is made:

- The ability of the market to provide Commercial service options as alternatives to Network Owner options to control high voltage
- The level of interest to provide a Commercial service to meet the identified long-term needs
- The likelihood of achieving a more economical and efficient overall solution by considering a wider range of options
- The delivery timescale of market-based options
- Preferred contract options

- 6.57 The RFI information pack will include an indicative timeline for the Tender Process, including when a decision to tender will be made.
- 6.58 The ESO decides whether to tender based on the information received from the RFI. The decision will be published alongside a final timeline for the Tender Process.
- 6.59 If a decision is made to tender, the ESO will publish the Tender Process information pack with selected contract options. The ESO expects the requirements published in the Tender Process information pack to be the same as those published in the RFI information pack, and the assessment methodology to be consistent with this methodology document. Any exception will be stated in the Tender Process information pack. Details in the Tender Process information pack supersede the details from the RFI.
- 6.60 Any parties interested to have their Commercial service options considered by the ESO should respond to the Tender Process. Any responses should use the proforma published as part of the Tender Process information pack.

### Creating voltage rules

- 6.61 Voltage rules are created to indicate the minimum number of generators required to meet voltage control requirements in a region. The voltage rules are formulated using system analysis results. This approach loosely simulates the close-to-real-time process for voltage management. Studies against generator sensitivities, as illustrated in the previous section, are carried out for each selected set of conditions to help determine the minimum number of generators required and define the voltage rules. Since generators differ in sizes, each generator will be assigned a size coefficient to reflect their different reactive power capabilities.
- 6.62 The ESO uses these voltage rules with the constraint cost modelling tool to simulate year-round system operation. The number of bid and offer actions required to maintain system voltages within the NETS SQSS can then be estimated.
- 6.63 The constraint cost saving for each proposed option can then be estimated. Representing those variations of study backgrounds and system conditions in the CBA is crucial to the credibility of the estimated constraint cost saving. These backgrounds and conditions will be built into the voltage rules and hence considered in the CBA.

### Assessing options

- 6.64 When the ESO receives options from potential providers (TOs, DNOs, Commercial service Providers), these options need to be modelled and analysed so their actual impact to system voltages can be understood. The assessment often includes many options; and it may be necessary to group a few options together to create the solution which can meet the system requirement in a region. It may also be more economical and efficient to group options from various providers together i.e. combining TO, DNO and Commercial service options, to meet the requirement. It is however inefficient and impractical to always assess – model and analyse - all possible groups of options. Therefore, the assessment process set out below is used to keep the modelling and analysis at a practical level.

- 6.65 The ESO will assess the options selected in the CBA and ensure those options satisfy the service and technical requirements before the final recommendation is made and the Tender Process concludes.
- 6.66 The ESO intends to analyse as many options and combinations as practically possible. Only if the number of options available means there are too many possible combinations, the ESO will perform a pre-assessment selection. For the avoidance of doubt, this pre-assessment selection is designed to keep the assessment practical for the high voltage management Process; the overarching principle of finding the most economical and efficient solution still applies.

#### Pre-assessment (applicable when a high number of options are available)

- 6.67 The ESO bases the pre-assessment selection on two main factors - effectiveness and cost. The pre-assessment aims at reducing the number of options to keep the number of possible combinations practical.
- 6.68 The ESO first calculates the equivalent effective MVAR compensation each option provides with respect to the same (set of) reference point(s) (effective MVAR). The relevant effectiveness factor is applied to each option according to its point of connection and its effective MVAR is calculated.
- 6.69 The ESO then considers the cost of the option. As the process considers options from TOs, DNOs and Commercial service Providers, it is expected that the costs of options will cover a range of service terms. Hence the cost per year of each option is used for comparison. See the section "Cost-benefit analysis" for more details on calculating the cost per year for each option.
- 6.70 The ESO considers the effective MVAR and cost per year of each option. A cost-effectiveness factor will be calculated for each option in the format £/effective MVAR per year.
- 6.71 Options are then ranked according to their cost-effectiveness factors. The options with greatest cost-effectiveness will be selected for the CBA.

#### Cost-benefit analysis

- 6.72 The cost-benefit analysis, as mentioned in previous sections, provides investment recommendation based on two primary factors – monetised benefits or security and operability. As a general principle, if there are several options which meet the requirement and satisfy either of the two primary factors, the CBA chooses the most economical and efficient options.

How does the ESO estimate constraint cost?

To estimate constraint cost, the ESO uses the same constraint cost modelling tool as NOA – AFRY's BID3. This provides consistency with NOA. The ESO uses BID3 to model a European economic dispatch and a GB constrained dispatch (re-dispatch). More information on BID3 can be found in section 2 of the NOA Methodology.

The tool is used to work out constraint (bid and offer) actions required to maintain voltage compliance against future simulated scenarios. The criteria applied to evaluate constraint actions for high voltage control is different to those used by NOA to determine network boundary flow related constraint actions. The criteria is linked to the minimum number of local generators required on the system to maintain voltage compliance by means of voltage rules. This requirement is informed by analysis on credible future backgrounds and system conditions.

BID3 applies voltage rules to simulate the bid and offer actions required to maintain voltage compliance. The focus here is to represent the reactive power capability of generators while keeping the MW cost as low as possible, therefore the cost to move a plant to its minimum stable generation position is priced. Where applicable, footroom requirements will be considered.

The high-level process for estimating constraint cost using BID3 is outlined below.

1. Run an economic market dispatch  
The BID3 model is dispatched for each future energy scenario.
2. Run a network constrained re-dispatch

Apply the forecast boundary capabilities and constraints based on the latest FES database and NOA investment recommendations. Re-dispatch the network as per the previous step.

3. Extract hourly data for pertinent plants for the voltage rules  
For the areas under consideration and according to the voltage rules determined from the technical studies, extract the hourly data relevant for all options under consideration.
4. Examine the hourly data to see what is required to fulfil the rules  
For each option, examine in turn the hourly data to see whether the rules are complied with or what actions need to be taken for them to be complied with. This then creates a list of actions for each option which need to be taken for every hour for the validity of the rules and for each scenario.
5. Cost the actions required based on bid and offer prices and minimum stable generation  
The cost of the bid and offer actions is taken from the assumptions made within the BID3 model and the actions required to meet the voltage rules costed.

How does the ESO estimate utilisation cost?

Utilisation cost will be dependent on a range of factors, such as the following:

- Rate: The ESO applies the current ORPS rate<sup>29</sup> or the contracted rate where applicable.
- Point of connection: Utilisation varies depending on where an option is and the network topology at its point of connection.
- Service duration: Duration an option will be active i.e. how often the ESO expects an option will be required to control high voltages.
- Equipment used: The different equipment used to provide the Commercial services affects how often and how long an option will be used.
- System needs: For example, whether the reactive power capability is required pre-fault and/or post-fault will impact how often and how long an option will be used.

It is impractical to calculate utilisation based on fixed point system analysis as utilisation varies with system conditions. To fairly recognise the utilisation cost, the ESO estimates it based on how the BM units or newly proposed options are anticipated to be used.

6.73 The CBA considers various factors, including but not limited to:

- System requirements for controlling high voltages
- Point of connection of option
- Effectiveness
- Assessment period
- MVAR capability provided by proposed option
- Flexibility to offer only part of the MVAR capability of proposed option
- Earliest-in-service date (EISD)
- Costs including costs to cover outages requirements

6.74 In previous sections, system requirements, point of connection and effectiveness have already been discussed in detail.

6.75 Assessment period is defined as the years over which the future voltage control requirements are reasonably clear and certain. This should be the same as the period for which the Tender Process requests for options.

6.76 Options may provide different MVAR capability in each year.

---

<sup>29</sup> The rate which the ESO pays BM providers for utilisation in £/MVarh under the default payment mechanism. The utilisation payment is updated monthly in line with market indicators as set out in Schedule 3 of the Connection and Use of System Code (CUSC).

- 6.77 In some cases, a provider who can offer only part of the MVar capability of its proposed option may help achieve an overall solution of lower cost to consumers. The ESO considers this flexibility when they select options to form the most economical and efficient solution(s).
- 6.78 EISD refers to the earliest date when an option will be available to provide the required reactive power.
- 6.79 The cost to provide the service can be split into capital costs and operational costs. All costs submitted should be in current financial year base prices. Table 6.2 below provides the various element of costs to be included as the capital cost and operational cost in TO options, DNO options and Commercial service options.

Table 6. 2 Details of capital and operational costs for each type of providers

Option providers	Capital cost	Operational cost
<b>TOs</b>	<ul style="list-style-type: none"> <li>Cost of the new assets associated with an option</li> <li>WACC to be applied to regulated assets</li> </ul>	<ul style="list-style-type: none"> <li>Maintenance</li> <li>System access</li> <li>Other ongoing operational cost associated to the option</li> </ul>
<b>DNOs</b>	<ul style="list-style-type: none"> <li>In the short term while the DNO options will be paid via the Balancing Service Contract, the cost of DNO options should be submitted via the Tender Process and in the same format as required by the Tender Process.</li> </ul>	
<b>Commercial service Providers</b>	Cost of connecting any new assets associated with an option to the electricity system (transmission or distribution)	<ul style="list-style-type: none"> <li>As per contract, which may include:               <ul style="list-style-type: none"> <li>Availability payment</li> <li>Utilisation payment</li> </ul> </li> </ul>

- 6.80 The capital cost is any infrastructure cost that will be incurred by a Network Owner (TOs or DNOs). The ESO applies the weighted average cost of capital (WACC) to any network infrastructure costs that will be incurred due to an option. The ESO will seek this information directly from the relevant Network Owner(s). The capital cost should be submitted as a spend profile, which indicates the financial year in which the capital will be spent. Costs should be in a single, specified price base year which is consistent with the base year used for tender bids.

Table 6. 3 Example of spend profile

Year	2020/21	2021/22	2022/23
<b>Cost £m</b>	5	10	8

- 6.81 The operational cost should include any maintenance, system access and other ongoing costs. The operational cost will be applied for each year that the option is utilised. The operational cost submitted may vary by year.
- 6.82 The benefits that each option provides will be discounted at the social time preference rate as laid out in the Treasury Green Book<sup>30</sup>. This process results in the present value (PV) of each cost and benefit.
- 6.83 The ESO first calculates the equivalent effective MVar compensation each option provides with respect to the same (set of) reference point(s) (effective MVar). The relevant effectiveness factor to each option is applied according to its point of connection and its effective MVar is calculated.
- 6.84 The ESO then calculates the cost of providing an effective MVar for each option. The operational cost per effective MVar will be calculated as the PV operational cost per year divided by the quantity of effective MVars provided.

<sup>30</sup> <https://www.gov.uk/government/publications/the-green-book-appraisal-and-evaluation-in-central-government>



$$PV \text{ Op. Cost per eff. MVA}r = \frac{PV \text{ Operational cost per year}}{\text{eff. MVA}rs}$$

6.85 The capital cost will be calculated as the PV capital cost divided by the product of the quantity of effective MVAr and the number of service years. Service years is defined as time that the option will be available and cost-effective within the assessment period.

$$PV \text{ Capital Cost per eff. MVA}r = \frac{PV \text{ Capital Cost}}{\text{eff. MVA}rs \times \text{Service Years}}$$

6.86 The sum of the operational and capital costs per effective MVAr will be the cost per effective MVAr for the option.

$$PV \text{ Cost per eff. MVA}r = PV \text{ Op. Cost per eff. MVA}r + PV \text{ Capital Cost per eff. MVA}r$$

6.87 The goal of the CBA is to find the most economic and efficient solution(s) to the problem for the GB consumer. An optimisation will be carried out across all years within the assessment period simultaneously to find the cheapest solution(s). This is to take into account the capital cost of each option which is independent of the number of years that the option is considered optimum.

6.88 With the cost per effective MVAr calculated, the bids will be stacked, with the lowest cost per effective MVAr at the top, and the highest at the bottom. In general, bids will be selected from the top first until the system requirement for effective MVAr has been met. The stack order may be altered if more cost-effective combinations become apparent.

6.89 The ESO may conduct this process for every year individually or across the entire assessment period as deemed appropriate.

6.90 A provider may submit an optimal bid in one year, but this does not guarantee the bid will be optimal in subsequent years if lower cost options are available. The lowest cost solution(s) over the entire assessment period will be chosen. Note that in some cases this may result in a more flexible or smaller option that is more expensive per MVAr to be chosen.

6.91 Within each yearly stack, the ESO forecasts the cost of procuring the system voltage need through the BM. This will be done by modelling future GB electricity markets using the latest future energy scenarios and assessing within each settlement period which generators will be able to provide a solution to voltage issues. The BM costs for procuring the need will be again converted into a cost per effective MVAr which will be placed within each yearly stack to compete against the submitted options.

6.92 An example of the stacks and the selection of winning bids (highlighted green) is shown below in Table 6.4. Please note that the costs shown are not reflective of any forecast, they have simply been chosen for demonstration purposes.

Table 6. 4 Example of selection of options based on cost per effective MVAr to achieve a solution with most economical and efficient total cost

<b>System need: 200MVA</b>				
Provider name	Flexible?	Provider effective capability (MVA)	Cost per effective MVA (cost/MVA)	Cost
Provider 1	Yes	50	10	500
Provider 2	Yes	100	14	1400
Provider 3	No	25	15	375
Provider 5	Yes	50 (25 procured)	18	450
Provider 4	No	50	17	
BM	Yes	200	22	
Provider 6	Yes	100	30	

- 6.93 The total cost in Table 6.4 is  $500+1400+375+450=2725$ . Note that Provider 5 is selected ahead of Provider 4 even though Provider 5 has a higher cost per MVar. This is because Provider 5 is more flexible and allows the system need to be met exactly. Using Provider 4 would result in the system need being exceeded by 25MVar and result in a higher total cost ( $500 + 1400 + 375 + 850 = 3125$ ). There is a cheaper (although not the cheapest) solution where Provider 4 is selected ahead of Providers 3 and Provider 5. This solution has a cost of  $500 + 1400 + 850 = 2750$  and exactly 200MVar is procured. In some cases, the system operator may allow excess MVar to be procured if this would result in a lower cost for the consumer and pose no operational issues.
- 6.94 The CBA recommends the options which should be taken forward. Given the size of the investments and the short lead times, these recommendations are a single lifetime decision. This means that when an option is recommended, that recommendation persists until the asset or service contract expires. This is different to the normal annual NOA least-worst regret (LWR) recommendations which are reviewed annually. Where a recommendation is marginal, the decision may be to reassess at a later date when there is greater certainty of the need. This is only possible where the EISD of the option is ahead of the need and so the option can be delayed.

## The Stability Management Process

### Regional approach

- 6.95 At a regional level, the distribution of regional inertia, short circuit level, dynamic voltage support can influence the stability of the local network and its users. The regional stability requirements are determined by the configuration of the local network and the nature of generation and demand in that region. Since short circuit current and reactive power, unlike real power, cannot be sent across long distances due to the reactance of the transmission network, it is most effective when applied close to the problem. Stability issues can therefore be grouped into regions and assessment of each region conducted separately. The stability management process looks into the stability needs on a regional basis.

### Screening process – selecting and prioritising regions

- 6.96 The ESO uses a screening process to help identify and prioritise the region(s) which should be further explored through detailed power system and cost-benefit analysis. This should bring consumers the best value by ensuring the secure, economical and efficient development focuses on challenging regions first. The screening process considers future trends of generation and demand and their potential impact of system operability due to decline in regional system strength (short circuit levels), regional inertia and regional dynamic voltage support.
- 6.97 The ESO will request feedback from the TOs as to which region(s) they believe should be assessed.

### Creating network models for analysis

- 6.98 The ESO will start with the GB system planning models to produce and update elements within it to ensure the models are fit for this purpose. Future backgrounds based on Future Energy Scenarios (FES) and system conditions considered appropriate based on expected trends of decline in regional system strength (short circuit levels), regional inertia, regional dynamic voltage support will be applied to the models for assessment.

### Identifying requirement

#### Collaborating with TOs/DNOs to optimise existing assets

- 6.99 This part of the process is similar to the one from high voltage management project (please see paragraph 6.27-6.29).

#### Analysing the size of the stability requirement

- 6.100 The ESO identifies the stability requirement based on system analysis. The requirement varies depending on the future backgrounds and system conditions. It is not practical to fully analyse all combinations of backgrounds and conditions. Hence, the ESO selects snapshots based on data mining techniques and engineering judgement to represent a fair number of variations of backgrounds and conditions. For stability analysis, the ESO considers future outlook of FES scenarios on regional short circuit level, regional inertia and regional dynamic voltage. This allows ESO to choose a generation and demand background to be studied in detail. The ESO determines the regional stability requirements by running time series fault simulations in an RMS tool (Power Factory) for a selected generation and demand background. The ESO carries out sensitivity scenarios to complete its detailed analysis. The ESO also considers how often such a need could arise over the future years.
- 6.101 The regional stability needs are determined by understanding regional voltage and frequency behaviours within a period of a transmission system disturbance (transmission system faults can last for up to 140ms), at fault clearance and immediately after a fault clearance and for at least 500ms after fault clearance. The stability of voltage and frequency waveforms allows ESO to understand the risks on the transmission system and to quantify the stability requirements.

### Calculating effectiveness factors

6.102 To allow a fair comparison to be made for all potential options, effectiveness factors are used when the ESO assesses options. The general principle used to calculate the effectiveness of an option is similar to the one in high voltage project (please see paragraph 6.35-6.42), instead of calculating effectiveness of options to provide reactive support, the effectiveness of option to provide short circuit current and/or dynamic reactive support is calculated for stability management process. More details will be published in any stability tender based on regional stability needs.

### Communicating requirements

6.103 Communicating process for system requirement between ESO and stakeholders is similar to the one from high voltage process (please see paragraph 6.43-6.46), instead of using SRF-V, SRF-S is used to exchange data.

### Requesting & collecting options

6.104 This part of the process is similar to the one from high voltage (please see paragraph 6.47-6.60), instead of using SRF-V, SRF-S is used to exchange data.

### Assessing options

6.105 Process is again very similar to high voltage management (please see paragraph 6.64-6.71), a cost effective factor is calculated for each option in the format £/effective MVA per year (as opposed to the £/effective MAVr per year used in high voltage management project) in order to compare and rank them in the CBA process later on.

### Cost-benefit analysis

6.106 In principle, a similar methodology to high voltage is used (please see paragraph 6.72). The stability cost benefit analysis will be dependent on drivers behind each region's stability requirements. For example, in Scotland the ESO's stability needs are primarily driven by low short circuit level, whereas in other areas of GB there may be different drivers. The stability cost benefit analysis will also take account of active power export for each option and discount providers due to the cost of balancing their active power elsewhere. The ESO will publish detailed assessment methodology applicable to a stability tender as part of a tender process.

## High Voltage and Stability Process conclusion

- 6.107 Based on the results of the CBA, the ESO recommends the solution which should be taken forward. The recommended solution could consist of only TO option(s), only DNO option(s), only Commercial Service Provider option(s), or any combination of these three types of options. If the CBA concludes that none of the options proposed in the process provides benefits against forecast BM cost to control high voltages, the ESO may accept no Network Owner options and/or Commercial Service Provider options.
- 6.108 If the recommended solution consists of TO option(s), the ESO will write to the relevant TO(s) to inform them of the recommendation to support an investment case.
- 6.109 If the recommended solution consists of Commercial Service Provider option(s), the ESO will contact the relevant provider(s) after publishing the tender outcome and proceed with procuring the selected option(s) using the Balancing Service Contract.
- 6.110 If DNO option(s) are recommended, in the short term while the DNO options will be paid via the Balancing Service Contract, the ESO will proceed with the DNO option(s) in the same way as with any Commercial Service Provider options.

## Tender outcome

- 6.111 Tender outcomes will be announced as soon as reasonably practicable once the analysis and other relevant verification and approval process conclude. Tender outcomes will be published on the ESO website.

## Regional report

- 6.112 A regional report on the high voltage and stability management process will be published after all the analysis and tender activities conclude. The report includes driver, requirement, effectiveness and recommended solutions. It is expected that most of the information will have been made available at the various stages in the process already by the time the report is published.
- 6.113 The report will not include sensitive information unless agreement has been established with the information owner or is permitted by legislations or code.
- 6.114 On publication the report will be placed on the ESO website as a PDF document.





# 7

## Early development of options

## Early development

### Introduction

- 7.1. The licence condition C27 obliges the ESO to undertake the early development of options in certain circumstances. These are where early development is not carried out by another transmission licensee or an option is suggested by other interested persons. For example, modelling of the network and/or options. The ESO has to do the early development to such a standard that it can perform economic studies on the options to adequately compare the relative suitability of options.
- 7.2. The ESO publishes its conclusions in the NOA report. This in turn provides the information to the industry about system needs and hence opportunities for them to invest.
- 7.3. Note that early development of options is different from ESO-led options such as commercial solutions.
- 7.4. We undertake early development of options to meet the requirements that the revised licence condition C27 outlines in paragraphs 23 and 24.
- 7.5. The ESO might conclude that an option is worth investigating further because it believes the costs of an option looks low compared to the benefits that it would expect to provide. The ESO accepts that its limited capability to study options' costs and earliest in-service dates limits the accuracy of its view of the costs of options it is developing. The consequence of this could be that an early development option has unduly favourable results at first which displaces and delays what turns out to be the best option. The ESO may make its costs and earliest in-service dates available for scrutiny which could lead to it revising the data put into the NOA economic process.

### Process

- 7.6. The ESO reviews options submitted for the NOA process. The ESO considers the following aspects when reviewing the options:
  - Whether there are enough options to meet the requirements on each boundary. We do this by comparing the capabilities against unconstrained flows modelled in BID3. This follows an initial screening to test that options are technically effective with some consideration of the cost.
  - If an option has been initially devised but then abandoned. In this case the ESO seeks to understand why the option has been abandoned and as a result the ESO might decide not to pursue the option.
  - If the ESO devises an option that the relevant party declines to adopt and develop.
- 7.7. **Interested persons** can suggest options and where they can give demonstrable evidence of benefit, the ESO can support them with further analysis or studies. The ESO may involve the TO in developing the options while protecting confidentiality as appropriate. In some cases the ESO might conclude that all possible avenues have been exhausted in which case there is no further action.

- 7.8. The ESO will apply a screening stage to filter options from interested persons if there are many and it is clear that some are more beneficial than others. This might be founded on engineering judgement based on the following factors:
- Genuine network need.
  - Operability.
  - Practicality, for instance delivery date.
  - Understanding of the costs.
  - Whether the same or similar option has been considered before and ruled out for good reason.
- 7.9. When the ESO carries out early development of an option, it needs to be able to determine the option's benefit, for instance how much it improves boundary capability, the cost and also the earliest in-service date. These are the key factors in the cost-benefit studies. The ESO forms a view on these using the following considerations:
- What the ESO's aim is, for example to improve capability when all other options have been exhausted. This provides an introduction to the nature of the option and the ESO's thinking such as new reactive compensation, new circuit(s).
  - The existing parts of the network that are affected, such as connection points for new circuits as well as desired substation layouts (double busbar versus other arrangements).
  - Technical parameters of the solution to allow technical studies of the option and determine, for instance, boundary capability and related effects such as fault levels. This might affect the overall benefit of the option as the net gain might be reduced or an investment like circuit breaker replacement might be needed elsewhere if fault levels exceed existing ratings.
  - An estimate of the capital cost and **earliest in service date** based on public cost data and making certain assumptions such as the proportion of a new route that is cable. The ESO consults with the relevant TOs about such examples for their views about an option's practicality.
- 7.10. The ESO undertakes no stakeholder or consenting engagement work. The ESO seeks the input of the relevant TOs to help it understand the factors that might affect an option.
- 7.11. If an option receives a proceed, the ESO seeks the support from the relevant TO(s) to develop the option. In this case the ESO informs all relevant parties.





# A

## Appendix A NOA study matrix

Assumption/Condition		Comments
Generation and Demand Scenarios	Leading the Way	Technical and economic assessment of the reinforcement options; sensitivity studies where appropriate
	Consumer Transformation	Economic assessment of the reinforcement options and technical assessment as required; sensitivity studies where appropriate
	System Transformation	Economic assessment of the reinforcement options and technical assessment as required; sensitivity studies where appropriate
	Steady Progression	Economic assessment of the reinforcement options and technical assessment as required; sensitivity studies where appropriate
Seasonal Boundary Capability	Winter Peak	Technical and economic assessment of the reinforcement options
	Spring/Autumn	Technical and economic assessment of the reinforcement options. Technical assessment of boundary capabilities can be calculated based on agreed scaling factors from winter peak capabilities which are validated against benchmarked results. Benchmarking is subject to availability of the model and agreement on generation despatch
	Summer	Technical and economic assessment of the reinforcement options. Technical assessment of boundary capabilities can be calculated based on agreed scaling factors from winter peak capabilities which are validated against benchmarked results. Benchmarking is subject to availability of the model and agreement on generation despatch
Boundary Capability Study Type	Voltage Compliance	
	Thermal	
Contingencies	N-1-1	
	N-1	
	N-D	
Network Reinforcements	Build reinforcements	
	Reduced-build reinforcements	Assessment of reduced-build reinforcement options



Assumption/Condition		Comments
	Operational reinforcements	Assessment of operational options
Study Years	Year 1	Assessment of alternative reinforcement options subject to availability
	Year 2	Assessment of alternative reinforcement options subject to availability
	Year 3	Assessment of alternative reinforcement options subject to availability
	Year 4	Assessment of build and alternative reinforcements options excluding those are subject to Ofgem agreement
	Year 5	Assessment of build and alternative reinforcements options excluding those are subject to Ofgem agreement
	Year 7	Assessment of build and alternative reinforcements options excluding those are subject to Ofgem agreement
	Year 10	Assessment of build and alternative reinforcements options excluding those are subject to Ofgem agreement



# B

## Appendix B System requirements form

We have changed the System Requirements Form template to an electronic form for parts B, C, E and F using a dedicated data room. The table below gives an overview of the SRF parts and a summary of the data content.

SRF Part	SOFI Content?	Description	Data content
<b>Part A – Boundary requirement and Capability</b>	Yes	ESO sends out a requirement level for each boundary which triggers the TO's response in providing options to meet the capability requirement level for that boundary. The form includes the BID3 unconstrained boundary transfers. Each boundary will have its own Part A.	The requirements listed are the transfer capabilities for each energy scenario for each of economy and security in tabulated and chart form. An example is later in this appendix.
<b>Part B – TO Proposed Options</b>	Yes	TO responds with an option that may partially or wholly meet the requirements set out by Part A. Each option will have its own Part B	Technical description of the option including: <ul style="list-style-type: none"> <li>• physical works.</li> <li>• diagram.</li> <li>• what requirement the option solves and how.</li> <li>• earliest in-service date.</li> <li>• any environmental impacts</li> <li>• other reference information including option name, status, reference number.</li> </ul>
<b>Part C – Outage Requirements</b>	Yes	TO responds with outage requirements for that option. Each option will have its own row in Part C.	Outage requirements to deliver the option: <ul style="list-style-type: none"> <li>• Reference number to match option described in Part B.</li> <li>• Year of outage which says if the outages span more than one year.</li> <li>• Circuits required out of service and duration.</li> <li>• Restriction on sequence of works.</li> </ul>
<b>Part D – Studied Option combinations</b>	Yes	TO and ESO supply how the options' capabilities have been studied to ensure that the ESO accurately and faithfully reproduces the options' order and capabilities in the economic analysis. Part D is a separate online form.	Boundary benefit data is captured in the handover tool: <ul style="list-style-type: none"> <li>• The option code that has been agreed with the ESO.</li> <li>• The absolute boundary benefit in MW that the option gives.</li> <li>• Whether the option depends on other reinforcements to give its benefit.</li> <li>• The order of the reinforcements in the sequence.</li> </ul>

SRF Part	SOFI Content?	Description	Data content
<b>Part E – Options’ Costs</b>	Yes	TOs supply asset and cost information to allow the ESO to proceed with ‘cost reasonableness’ (See Appendix C). Each option will have its own Part E, but only if it has featured in Part D.	The data recorded includes: <ul style="list-style-type: none"> <li>• WACC used.</li> <li>• A limited break down of costs.</li> <li>• The cost profile for the option.</li> <li>• Delay, remobilisation costs.</li> </ul>
<b>Part F – Publication Information</b>	No	TOs supply names and descriptions of options for publication use. Each option will have its own row in Part E but only if it has featured in Part D.	The information includes: <ul style="list-style-type: none"> <li>• The NOA code agreed with the ESO.</li> <li>• The option name to appear in the NOA report.</li> <li>• The description of the option to appear in the NOA report.</li> </ul>

SOFI stands for System Operator Functions Information.

SRF Part A: Boundary Requirement and Capability

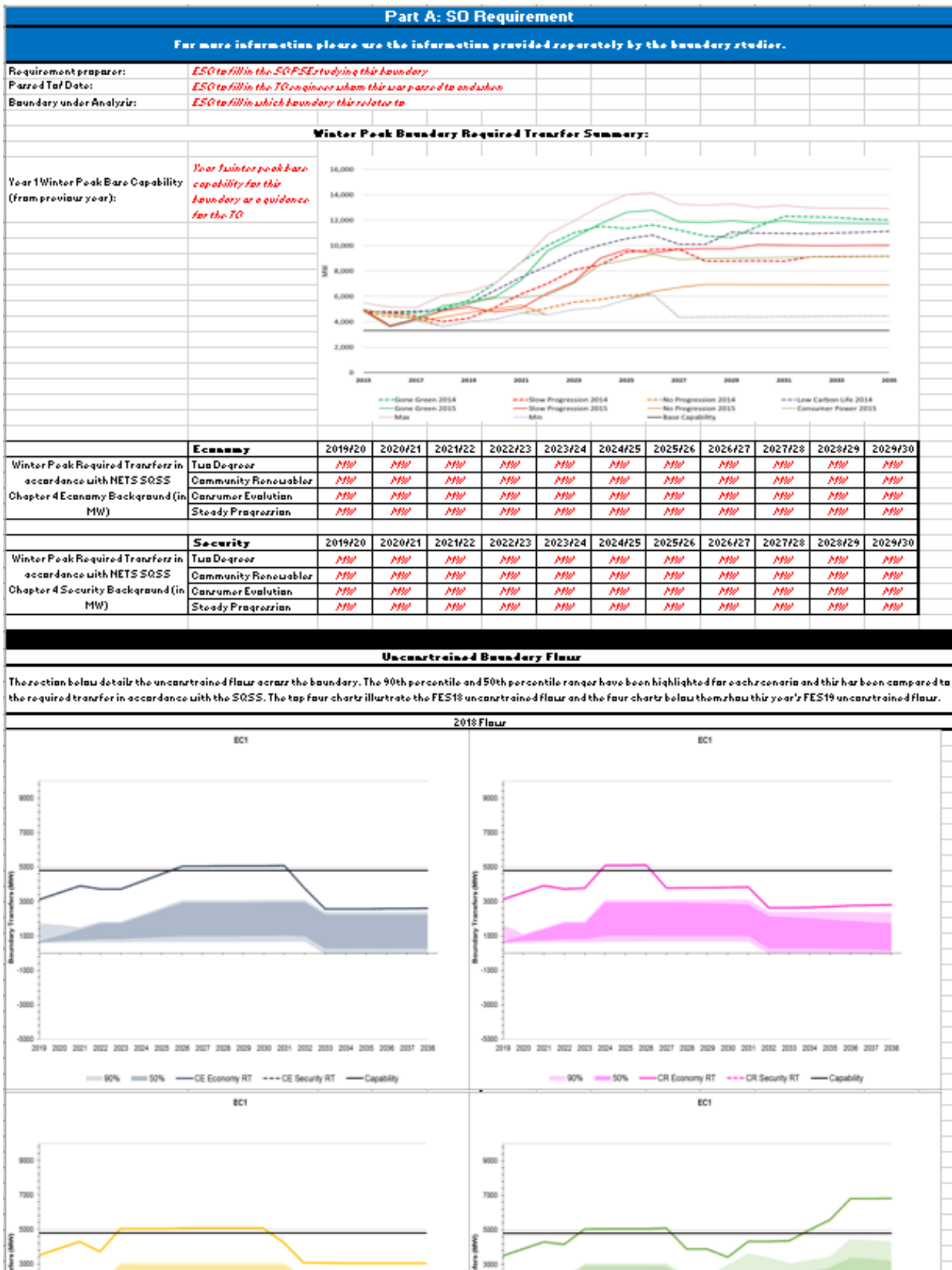



Seasonal scaling factors can be submitted using the following template. Otherwise, default ones mentioned in Section 2 will be used or actual seasonal boundary capabilities can also be submitted separately.

Boundary Name	Seasonal Scaling Factor				Number of circuits crossing boundary	Number of outage days
	Winter	Spring/Autumn	Summer	Summer Outage		
<b>Example</b>	100%	85%	70%	50%	4	
B0						
B1						
B2						
B4						
B5						
B6						
B7						
B8						
B9						
B13						
EC5						
SC1						
SC1rev						
NW1						

**Please enter data into column H OR column I.** The number of outage days will be calculated based on the number of circuits crossing the boundary unless the number of outage days is specified.

Lock/unlock

**Use this page to enter seasonal scaling factors for boundaries studied.**





# C

## Appendix C Process for checking NOA option cost reasonableness

This appendix describes the process that the ESO uses to assess the NOA option cost data that the TOs provide as an input to the NOA economic process.

Figure E1 shows the process map for the cost reasonableness checking process.

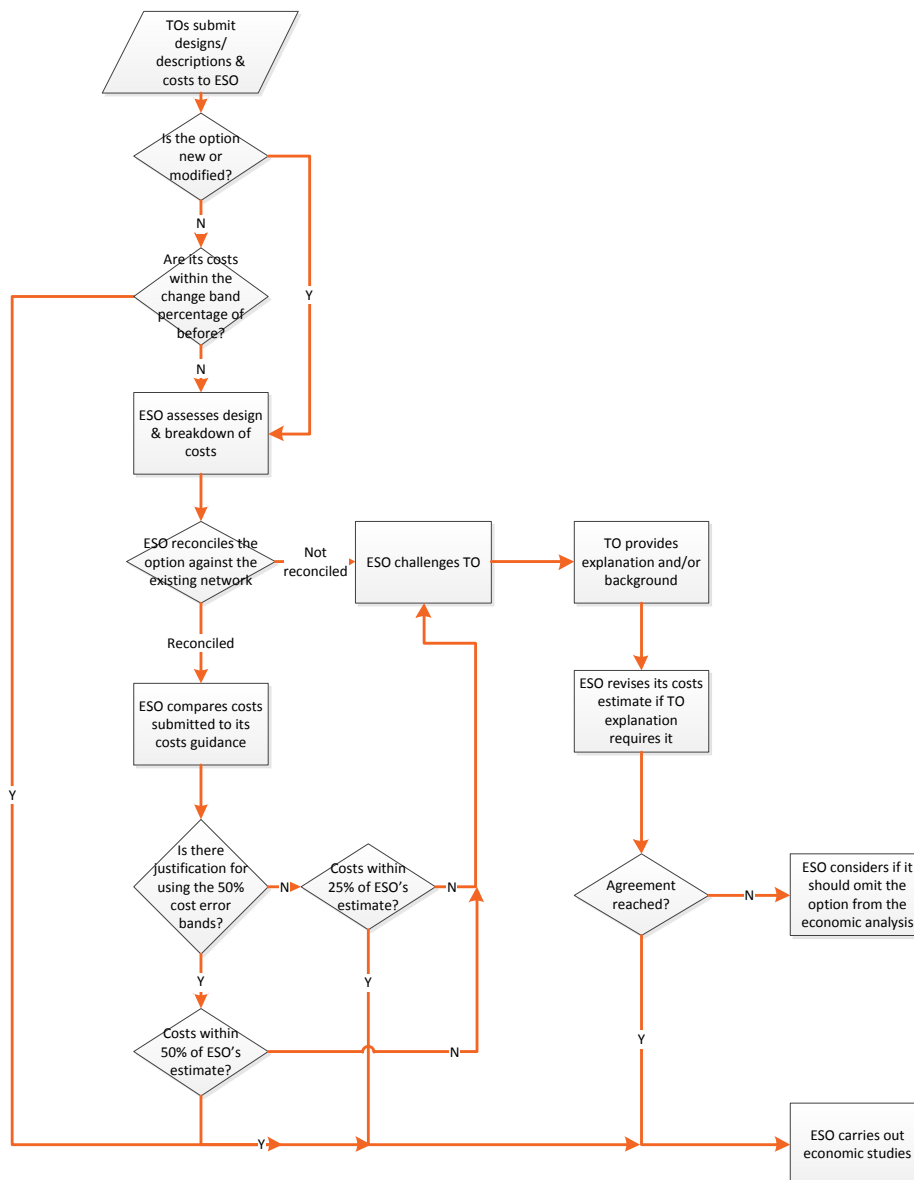

Figure E1: cost reasonableness checking process map

The input to the process is the costs that the TOs submit for their NOA options. The output of the process is the TOs' cost submissions to be deemed valid and act as an input into the NOA economic process. The TOs may modify their costs following discussions with the ESO as part of this process. If following discussions, the ESO still believes that the costs are outside of their expected range and will consequently unduly affect the economic analysis, the ESO may omit the option from the economic analysis.

The ESO maintains independent cost guidelines which are derived from RIIO unit costs and external public domain market intelligence. The ESO compares the costs of different options from a TO against previous years (allowing for inflation) and against its cost guidelines.

The headings below match the stages in the process map.

### TOs submit designs/descriptions & costs to ESO

Having received the cost information from the TOs via the SRFs, the ESO gathers the information together. The ESO needs the following data, which it captures from the SRF:



Detailed technical breakdown of the reinforcement option

Cost data for the option.

### Is the option new or modified?

### Are its costs within the change band percentage of before?

The first step is for the ESO to identify which options should proceed through the cost reasonableness process. New or modified options always proceed through the cost reasonableness process. Options where the designs are unmodified from previous years' submissions may be exempt from the remainder of the cost reasonable process as they will have had their costs approved through previous years' ESO cost checks, provided any increase in costs falls within an expected range. If the costs submitted for the current year are within the change band of +/- 5% of previous submissions, then the cost checking process for such an option ends here. Options where the costs have changed outside this range, or options which have modified or new designs, proceed through the process as normal.

### ESO assesses design & breakdown of costs

The aim of this step is for the ESO to understand the option, how it is intended to deliver the benefit, the component parts of the option and its benefit. The ESO takes the technical breakdown descriptions of the option and builds up its understanding of the reinforcement option:

The ESO checks the descriptive text with any diagrams that the TO has provided. Note that some options will not need diagrams, for instance if they are about thermal upgrades or other overhead line work.

The ESO checks that equipment requirements are consistent and complete. For instance, where a new circuit is proposed, does the SRF explain how it will connect to the existing transmission system – are new bays proposed and how many, or will it reuse existing bays? Is equipment already installed mentioned separately from equipment that will be installed in the future?

The ESO checks environmental factors. For example, whether the option needs consents and whether the option is in a mainly urban or rural setting.

It is expected that the level of disaggregation of options included in the SRF and the cost accuracy will vary with the level of maturity of the option, with those options which have been developed over a few years being broken down into more detailed aggregate components with more accurately estimated costs than those in the initial stages of conception where design and costs are more approximate.

### The ESO reconciles the option against the existing network

Having built up its understanding of the option, the ESO checks the existing part of the network that the option affects. This is to identify any parts of the option that might have been omitted and which may affect the cost estimate. The ESO notes any omissions or discrepancies in the SRF and seeks clarification from the TO. An example might be that the SRF describes using a spare bay so the ESO checks the latest system diagram to check for the bay's details. For an explanation of the remainder of the process, go to the **ESO challenges TO** stage on the process map.

### ESO compares costs submitted to range of costs in its guidelines

The ESO performs two tests for each option at this stage as applicable.

- 1) Having developed its understanding of the option, the ESO compares the option's costs against the ESO's cost guidelines.
- 2) The ESO identifies similar options within a TO's portfolio and checks the cost consistency between them. For instance, where two options replace the conductors of circuits of the same voltage level, the ESO calculates the unit costs based on the TO's submission and checks how similar they are.



### Is there justification for using the 50% cost error bands?

Some aspects of options add a lot of uncertainty to the forecast cost of a project and so are allowed a larger cost error. For this reason, the ESO measures against a 50% cost error band for any option affected by the following:

consents

new technology with high uncertainty.

### Costs within 25% of ESO's estimate?

This step applies to options that involve **no** added justification for the wider cost error bands.

The first stage is for the ESO to compare the TO's submission with its own estimate of costs. If the costs are within 25%, the ESO progresses to the second stage.

The second stage is to check that a TO's costs are consistent with other options' costs across its portfolio. If this is the case, then the ESO sets the option costs as 'agreed' and the costs are used in the economic process.

If the costs are outside of the 25% band and/or the costs are not consistent, the ESO asks the TO for justification. For an explanation of the remainder of the process, go to **ESO challenges TO** stage on the process map.

### Costs within 50% of ESO's estimate?

This step applies **only** to options where there is justification for wider cost error bands and is a similar two stage approach.

Firstly, the ESO takes the TO's submission and compares it with its own estimate of costs. If the costs are within the 50%, the ESO progresses to the cost consistency check across a TO portfolio.

If the costs are consistent with other options' costs in the TO portfolio, then the ESO sets the option costs as 'agreed' and the costs are used in the economic process.

If the costs are outside of the 50% band and/or the costs are not consistent, the ESO asks the TO for justification. For an explanation of the remainder of the process, go to the **ESO challenges TO** stage on the process map.

### ESO challenges TO

If the ESO finds that an option's costs lie outside of the range that it estimates, it approaches the TO for a more detailed understanding.

### TO provides explanation and/or background

In response to the ESO's challenge, the TO provides more information to solve the query. This information might be:

adding information, for instance including the details of cable section lengths

correcting assumptions about assets, for instance the amount of plant involved in work on a substation bay

amending a cost submission due to an error

the TO challenges the ESO's understanding of costs or option scope.

This is part of an iterative stage.

If the TO provides more information to the ESO, the ESO will revise its cost estimation accordingly to check if the costs are within the 25% bracket or 50% bracket as applicable. If 'yes', then the ESO sets the option costs as 'agreed' and the TO's costs are used in the economic process.

If the TO's response means that the ESO's concerns remain, the ESO reviews its concern, clarifies it and refers it back to the TO.

If after several attempts, the ESO cannot agree to the costs and explanations that the TO is providing, the ESO engineer escalates the matter within ESO management. The ESO management decides whether to include the costs for the option in question at this stage or to omit it from the economic analysis.

### ESO revises its costs estimate if TO explanation requires it

The discussion between the ESO and the TO might mean that the ESO has to recalculate its estimate of the costs. The ESO notes the revised costs.

### Agreement reached?

The ESO engineer conducting the process passes the 'agreed' TO costs for use in the NOA economic process.

### General points

The ESO keeps the cost information for all options submitted by each TO and uses them to do consistency checks of options that the same TO submits in future years.

In general, the ESO assumes that the TO cost submissions include the development costs. There might be occasions on which the submissions do not include the development costs in which case the TO and ESO will discuss this further and decide how to proceed with the option for its economic analysis.



# D

## Appendix D Form of report

*The Electricity System Operator (ESO) will produce the main NOA report which will be public and produce appendices where there is confidential information. The confidential appendices will contain full cost details of options and will have very limited circulation that will include Ofgem. Extracts of this report will go to the relevant Transmission Owners (TO). The main NOA report will omit commercially confidential information. We will provide Ofgem with justification for the redactions. This appendix describes the contents and chapters of the report. The ESO reserves the right to add or change chapters to better represent the NOA information.*

## **Foreword**

## **Contents Page**

## **Executive Summary**

The executive summary will include headline information on options listing those that meet SWW criteria.

## **Chapter 1: Introduction and Aim of the Report**

This chapter will describe the aim of the NOA report, provide the reader with clear guidance on its relationship with the Electricity Ten Year Statement (ETYS) and give guidance on how to navigate the NOA report.

## **Chapter 2: Methodology description and variations**

This chapter will describe the assessment methodology used at a high level and refer the reader to the NOA report Methodology statement published on National Grid ESO's public website.

The chapter will also include the definition of and commentary on Major National Electricity Transmission System Reinforcement options. We will include a description of how the ESO treats Strategic Wider Works (SWW).

We expect options to improve boundary capabilities will fall broadly into three categories:

SWW that have Ofgem approval. The NOA report will refer to these options which will be included in the baseline while presenting no analysis. The Report will justify why these options are treated as such.

Options that have SWW analysis underway. This analysis and available results will be used in the NOA report.

Options analysed using the Single Year Regret cost-benefit analysis. This analysis will appear in the NOA report.

Should any options fall outside of these three categories, the chapter will list them with an explanation as to how and why they are treated differently.

## **Chapter 3: Proposed Options**

This chapter is to give an overview of the options that the ESO has assessed. The overview will group options by study region and by their technical type including whether it is build or reduced build. More detailed information on each option that will include status will be listed in an appendix. The chapter will include OWW options or record a nil return if there are none. It will also include a commentary on reduced-build or non-transmission ones, where applicable. The chapter will also include a short summary of the boundaries that make up the GB electricity network.

## **Chapter 4: Investment Recommendations**

This chapter will cover the economic benefits of each option. The data will be tabulated and to support the comparison include earliest in service (EISD) and optimum delivery dates. An explanation of the regrets for the options and combinations of options where the options are critical will be included as an appendix of the report, i.e. those that need a decision to proceed (or otherwise) imminently. Chapter 4 will detail the ESO recommendation whether to proceed with each option. In some instances, there might be a recommendation to proceed with more than one option. Such an instance could be at an early stage when two options are closely ranked but there is uncertainty about key factors for example deliverability.



The chapter will indicate options that are likely to meet the competition criteria. As the competition framework is uncertain due to the necessary legislation not being passed, the chapter will highlight this. The chapter will explain how options meet competition criteria.

The chapter will finish with a summary of the options for the boundary. It will provide:

Any differences in preferred options between annual NOA reports where the ESO has carried out similar analysis in the past.

How the scenarios have different requirements and how they affect the options.

A comparative view of each option's deliverability and how it affects the choice of the preferred options.

Chapter 4 will meet the ESO obligation to produce the recommendations for the Network Development Policy for Incremental Wider Works.

Certain details will be in the appendices and that will include the cost bands for options as appropriate.

### **Chapter 5: NOA for Interconnectors**

This section of the report will introduce the method of analysing GB's potential for interconnectors to other markets and publish the analysis.

### **Chapter 6: Stakeholder engagement and feedback**

To help our understanding of stakeholder views, through the document we will include feedback questions. We will use this feedback to refine the NOA report process and methodology for the next report.

We have used our seminars to continue to talk with stakeholders and have received some interest. Onshore TOs have engaged with us and assisted in developing this NOA report methodology. We want to extend our engagement further and will use our NOA email circulation lists.

### **Glossary**





# E

## Appendix E Summary of stakeholder feedback

